



ALONDRA

BABY FURNITURE & DECOR



CATALOGUE

CO-SLEEPERS



Page 3

Co-sleepers | Colecho
Cododo | *Beistellbetten*
Fianco letto

CO-SLEEPING COT

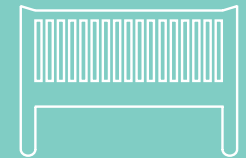

Page 13

Co-sleeping Cot | Cuna de Colecho
Lit bébé Cododo | *Beistellbetten*
Letino Fianco letto

MONTESSORI



Page 35

Montessori beds | Camas Montessori
Lits Montessori | *Montessori-Betten*
Lettini Montessori

KONVERS

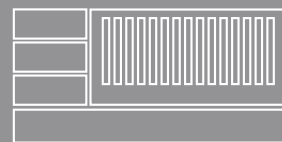

Page 47

Convertible cribs | Cunas convertibles
Lits bébé évolutifs | *Verwandeltbare Babybetten*
Lettini trasformabili

BABY FURNITURE

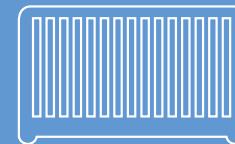

Page 71

Baby rooms | Habitaciones infantiles
Chambres de bébé | *Babyzimmer*
Camerette per bambini

COTS & BATH CHANGERS



Page 93

Cots and bath changers | Cunas y bañeras
Lits bébé et baignoires | *Babybetten + Waschtische*
Lettini e bagnetti

JUNIOR FURNITURE



Page 101

Junior furniture | Mobiliario juvenil
Mobilier junior | *Jugendmöbel*
Mobili junior

NURSING CHAIRS



Page 105

Nursing chairs | Sillones de lactancia
Fauteuils d'allaitement | *Stillsessel*
Poltrone allattamento

NURSERY LIGHTING



Page 115

Lamps & deco | Lámparas y decoración
Lampes et décoration | *Lampen und Dekoration*
Lampade e decorazione

TOYS



Page 119

Toys | Juguetes
Jouets | *Spielzeuge*
Giocattoli

URBAN BAGS



Page 125

Nursing bags | Bolsos de maternidad
Sacs à langer | *Wickeltaschen*
Borse mamma

TEXTILES



Page 139

Textiles | Textiles
Layette | *Textilien*
Tessile

DECO



Page 161

Co-sleepers | Colecho
Cododo | *Beistellbetten*
Fianco letto

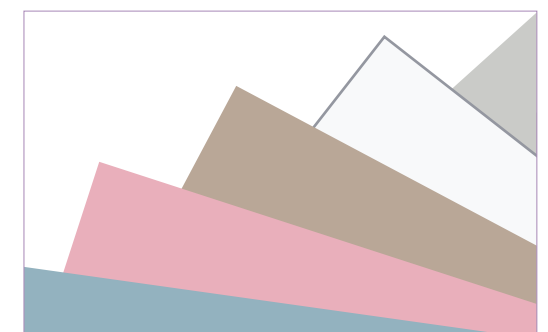

Page 166

Colours | Colores
Couleurs | *Farben*
Colori



7 heights / alturas

(Mattress included)

54,3 cm

51,1 cm

47,9 cm

44,7 cm

41,5 cm

38,3 cm

35,1 cm

⬆ Min. 65,1 cm / Max. 84,3 cm

➡ 89,2 cm

↻ 63 cm

C1055-TX055

50x80 cm



7 heights / alturas

(Mattress included)

- 54,3 cm
- 51,1 cm
- 47,9 cm
- 44,7 cm
- 41,5 cm
- 38,3 cm
- 35,1 cm

↑ Min. 65,1 cm / Max. 84,3 cm

→ 89,2 cm

↻ 63 cm

C1794-TX194
50x80 cm

EQUO



C1077-TX181



C1055-TX055



C1078-TX178



C1077-TX182



C1052-TX112



C1051-TX111



EQUO

EQUO LIFE



C1078-TX114



C1077-TX179



C1794-TX194



C1053-TX194



C1053-TX153



C1794-TX153

5 STAGES | 5 ETAPAS | 5 ÉTAPES | 5 ETAPPEN | 5 FASI



INCLUDES | INCLUYE | INCLUT | BEINHALTET | COMPRENDE

**SIZES | MEDIDAS
MESURES | MAßE | MISURE**

7 heights / alturas *

- 54,3 cm
- 51,1 cm
- 47,9 cm
- 44,7 cm
- 41,5 cm
- 38,3 cm
- 35,1 cm

Ref. C10
Ref. C17

Co-sleeping crib
Minicuna de colecho
Berceau cododo
Beistellbett
Culla fianco letto



4 wheels with brake
4 ruedas con freno
4 roues avec frein
4 Räder mit Bremse
4 ruote con freno

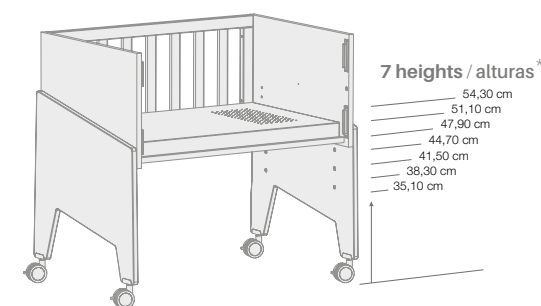

* Height with mattress (5cm) included
Altura con colchón de 5cm incluido



Attachment straps
Sistema de sujeción a la cama incluido
Système de fixation au lit
Befestigungssystem am Bett
Sistema di ancoraggio al letto

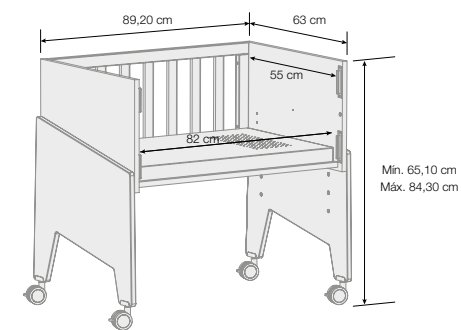

Textiles 50x80 cm

* Height with mattress included | Altura con colchón incluido
Hauteur du couchage, matelas compris | Höhenverstellung mit Matratze | Altezza con materassino incluso

DETALLES | DETAILS | DÉTAILS | DETAILS | DETTAGLI



Straps with velcro
Cintas con velcro
Sangles à scratch
Klett-Gurten
Dettaglio cinghie con velcro



Co-sleeping stage
Etapa colecho
Étape cododo
Beistellbett Etappe
Fase fianco letto



Fastening straps attached to the bed
Detalle sistema sujeción unido a la cama
Système de fixation au lit
Befestigungssystem am Bett
Dettaglio sistema ancoraggio letto



Inside dimensions
Medidas interiores minicuna
Mesures intérieures
Innenmaße
Misure interne

CO-SLEEPING CRIB | MINICUNA DE COLECHO
BERCEAU CODODO | BEISTELLBETT | CULLA FIANCO LETTO

5in1*

EQUO

50x80 cm



TEXTILE PACK | PACK TEXTIL
 PACK TEXTILE | *TEXTIL-SET* | PACK TESSILE

REF. 650

4 PIECES
 Quilt with padding included
 Bumper 3 sides
 Bumper 1 side
 Breathable mattress

4 PIEZAS
 Colcha con relleno
 Protector 3 lados
 Protector 1 lado
 Colchón antiahogó plástico

4 PIÈCES
 Couvre-lit avec rembourrage
 Tour de lit 3 côtés
 Tour de lit 1 côté
 Matelas anti-étouffement

4 STÜCKE
 Bettdecke mit Füllung
 3-seitiges Nestchen
 1-seitiges Nestchen
 Matratze Antierstickungsgefahr

4 PEZZI
 Plumoncino con imbottitura
 Paracolpi 3 lati
 Paracolpi 1 lato
 Materassino antisoffoco plastificato



Xbreathable mattress
 Detalle colchón antiahogó
 Matelas anti-étouffement
 Matratze Antierstickungsgefahr
 Materassino antisoffoco plastificato

REF. 650S

3 PIECES
 Quilt with padding included
 Bumper 3 sides
 Bumper 1 side

3 PIEZAS
 Colcha con relleno
 Protector 3 lados
 Protector 1 lado

3 PIÈCES
 Couvre-lit avec rembourrage
 Tour de lit 3 côtés
 Tour de lit 1 côté

3 STÜCKE
 Bettdecke mit Füllung
 3-seitiges Nestchen
 1-seitiges Nestchen

3 PEZZI
 Plumoncino con imbottitura
 Paracolpi 3 lati
 Paracolpi 1 lato

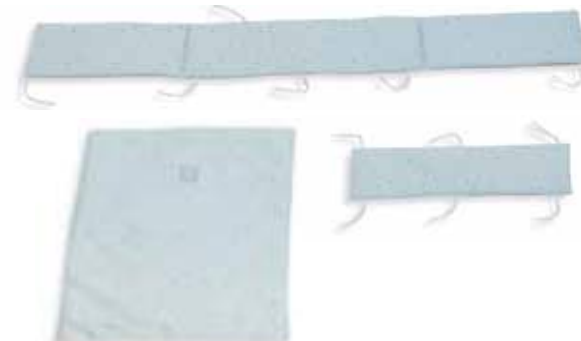

MEASURES | MEDIDAS
 MESURES | *MAÛE* | MISURE

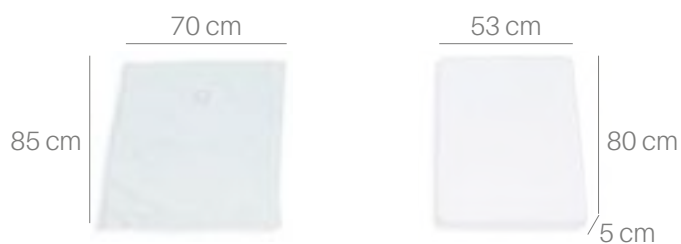

DETAILS | DETALLES | DÉTAILS | *DETAILS* | DETTAGLI



2 bumper velcro fastenings included
 2 sujeciones protector incluidas
 2 fixations de scratch incluses
 2 Klett-Befestigungen inklusive
 2 ancoraggi velcro paracolpi inclusi



Reversible bumper
 Protector reversible / 2 caras
 Tour de lit réversible
 Doppelseitiges Nestchen
 Paracolpi reversibile 2 lati



OPTION | OPCIÓN
 OPTION | *OPTION* | OPZIONE















Memory foam mattress
 Colchón viscoelástica opcional
 Matelas à mémoire de forme
 Matratze aus Viscoschaum
 Materassino memory foam opzionale

Ref. ZY50-80
 5 cm
 80 cm
 50 cm



SIZE
50x80
cm

 <p>Crib without textile & mattress Minicuna sin textil y sin colchón Berceau sans textile et matelas Stubenwagen ohne Textil und Matratze Culla senza tessile e materassino</p>	 <p>Textile & mattress (without crib) Textil+colchón (sin minicuna) Textile et matelas (sans berceau) Textil und Matratze (ohne Wiege) Tessile+materassino (senza culla)</p>	 <p>Textile (without crib) Textil (sin minicuna) Textile (sans berceau) Textil (ohne Wiege) Tessile (senza culla)</p>							
<p>---</p>	<p>---</p>	<p>---</p>	<p>C10-M7751</p>	<p>C10-M7752</p>	<p>C10-M7753</p>	<p>C10-M7755</p>	<p>C10-M7700</p>	<p>C10-M7778</p>	<p>C17-M9477</p>
	<p>650-055</p>	<p>650S-055</p>	<p>---</p>	<p>---</p>	<p>---</p>	<p>C1055-TX055</p>	<p>C1077-TX055</p>	<p>C1078-TX055</p>	<p>---</p>
	<p>650-111</p>	<p>650S-111</p>	<p>C1051-TX111</p>	<p>---</p>	<p>---</p>	<p>---</p>	<p>C1077-TX111</p>	<p>C1078-TX111</p>	<p>---</p>
	<p>650-112</p>	<p>650S-112</p>	<p>---</p>	<p>C1052-TX112</p>	<p>---</p>	<p>---</p>	<p>C1077-TX112</p>	<p>C1078-TX112</p>	<p>---</p>
	<p>650-153</p>	<p>650S-153</p>	<p>---</p>	<p>---</p>	<p>C1053-TX153</p>	<p>---</p>	<p>C1077-TX153</p>	<p>---</p>	<p>C1794-TX153</p>
	<p>650-178</p>	<p>650S-178</p>	<p>---</p>	<p>---</p>	<p>---</p>	<p>---</p>	<p>C1077-TX178</p>	<p>C1078-TX178</p>	<p>---</p>
	<p>650-179</p>	<p>650S-179</p>	<p>---</p>	<p>---</p>	<p>---</p>	<p>---</p>	<p>C1077-TX179</p>	<p>C1078-TX179</p>	<p>---</p>
	<p>650-181</p>	<p>650S-181</p>	<p>---</p>	<p>---</p>	<p>---</p>	<p>C1055-TX181</p>	<p>C1077-TX181</p>	<p>C1078-TX181</p>	<p>---</p>
	<p>650-182</p>	<p>650S-182</p>	<p>---</p>	<p>C1052-TX182</p>	<p>---</p>	<p>---</p>	<p>C1077-TX182</p>	<p>C1078-TX182</p>	<p>---</p>
	<p>650-114</p>	<p>650S-114</p>	<p>---</p>	<p>---</p>	<p>---</p>	<p>---</p>	<p>C1077-TX114</p>	<p>C1078-TX114</p>	<p>---</p>
	<p>650-194</p>	<p>650S-194</p>	<p>---</p>	<p>---</p>	<p>C1053-TX194</p>	<p>---</p>	<p>C1077-TX194</p>	<p>---</p>	<p>C1794-TX194</p>

CO-SLEEPING COT

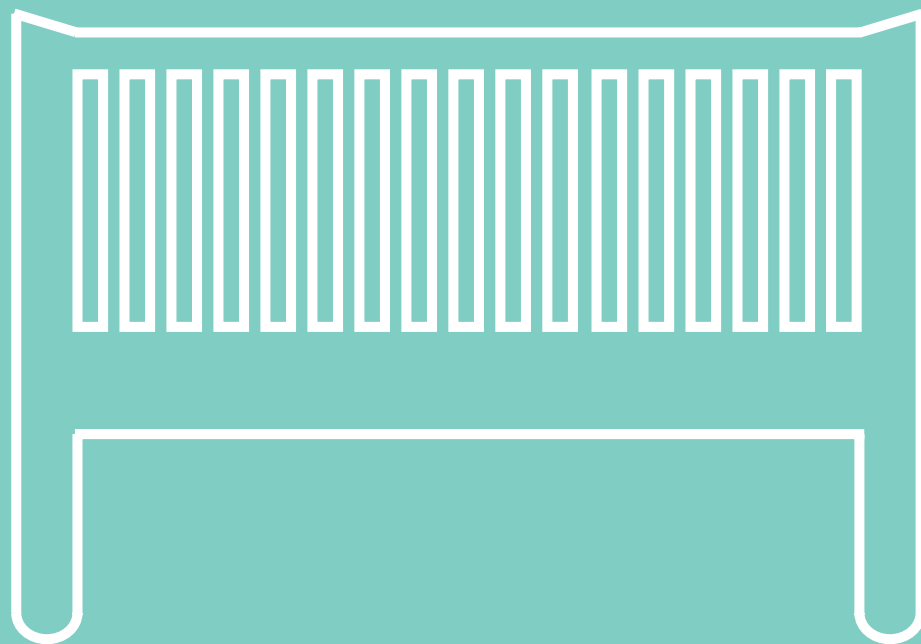

CO-SLEEPING COT | CUNA DE COLECHO | LIT BÉBÉ CODODO
BEISTELLBETT | LETTINO FIANCO LETTO

OMNI

60x120 cm



OMNI

91 x 126,1 x 72,9 cm



Ref. C181

* 5 stages with additional kits or accessories
5 etapas con packs o accesorios adicionales
5 étapes avec des kits ou accessoires supplémentaires
5 Etappen mit zusätzlichen Kits oder Zubehör
5 fasi con packs o accessori opzionali

* 5 STAGES | 5 ETAPAS | 5 ÉTAPES | 5 ETAPPEN | 5 FASI

STAGE
1
0-1 years



Co-sleeping cot | Cuna de colecho
Lit bébé cododo | Beistellbett
Lettino fianco letto

STAGE
2
1-2 years



Cot | Cuna
Lit bébé | Babybett
Lettino

STAGE
3
2-5 years



Toddler bed | Camita infantil
Lit cadet | Juniorbett
Lettino sponda junior

STAGE
4
5-7 years



Couch | Sofá infantil
Canapé | Sofa
Divanetto

STAGE
5
5-14 years

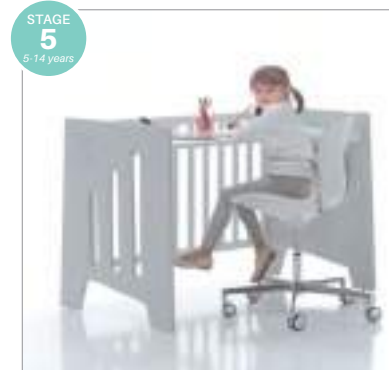

Desk | Escritorio infantil
Bureau | Schreibtisch
Scrivanía



70x140 cm



Optional 4 wheels (page 26)
4 ruedas opcional (pág.26)
4 roues supplémentaire (page 26)
4 Räder (seiten 26)
4 ruote supplementare (pagina 26)

*** 6 STAGES**
6 ETAPAS | 6 ÉTAPES
6 ETAPPEN | 6 FASI

STAGE
1
0-1 years



Co-sleeping cot | Cuna de colecho
Lit bébé cododo | Beistellbett
Letтино fianco letto

STAGE
2
1-2 years



Cot | Cuna
Lit bébé | Babybett
Letтино

STAGE
3
2-5 years



Toddler bed | Camita infantil
Lit cadet | Juniorbett
Letтино sponda junior

STAGE
4
2-5 years



Montessori bed | Camita Montessori
Lit cadet Montessori | Montessori-Juniorbett
Letтино Montessori

STAGE
5
5-7 years



Couch | Sofá infantil
Canapé | Sofa
Divanetto

STAGE
6
5-14 years



Desk | Escritorio infantil
Bureau | Schreibtisch
Scrivanía



OMNI XL

90,5 x 146,1 x 82,5 cm



Ref. C191

* 6 stages with additional kits or accessories
6 etapas con packs o accesorios adicionales
6 étapes avec des kits ou accessoires supplémentaires
6 Etappen mit zusätzlichen Kits oder Zubehör
6 fasi con packs o accessori opzionali



C181-M7751 + WJB180-M77
(pages 22-23)

633-111

B754-M7751

OMNI CIELO



(60 x 120 cm)



OMNI
C181-M7751

- ↑ 90,5 cm
- 126,1 cm
- ↻ 73 cm

* 5 stages with additional kits or accessories (+info pages 22-23)
 5 etapas con packs o accesorios adicionales (+info págs. 22-23)
 5 tapes avec des kits ou accessoires supplémentaires (+info pages 22-23)
 5 Etappen mit zusätzlichen Kits oder Zubehör (+info Seiten 22-23)
 5 fasi con packs o accessori opzionali (+info pagine 22-23)



(70 x 140 cm)



OMNI XL
C191-M7751

- ↑ 90,5 cm
- 146,1 cm
- ↻ 82,5 cm

* 6 stages with additional kits or accessories (+info pages 24-25)
 6 etapas con packs o accesorios adicionales (+info págs. 24-25)
 6 tapes avec des kits ou accessoires supplémentaires (+info pages 24-25)
 6 Etappen mit zusätzlichen Kits oder Zubehör (+info Seiten 24-25)
 6 fasi con packs o accessori opzionali (+info pagine 24-25)

2 SIZES: 60x120 / 70x140 cm



C181-M7752 + WJB180-M77
(pages 22-23)

633-112

B754-M7752

OMNI CORAL

(60 x 120 cm)



OMNI
C181-M7752

- ↑ 90,5 cm
- 126,1 cm
- ↻ 73 cm

* 5 stages with additional kits or accessories (+info pages 22-23)
5 etapas con packs o accesorios adicionales (+info págs. 22-23)
5 tapes avec des kits ou accessoires supplémentaires (+info pages 22-23)
5 Etappen mit zusätzlichen Kits oder Zubehör (+info Seiten 22-23)
5 fasi con packs o accessori opzionali (+info pagine 22-23)

(70 x 140 cm)



OMNI XL
C191-M7752

- ↑ 90,5 cm
- 146,1 cm
- ↻ 82,5 cm

* 6 stages with additional kits or accessories (+info pages 24-25)
6 etapas con packs o accesorios adicionales (+info págs. 24-25)
6 tapes avec des kits ou accessoires supplémentaires (+info pages 24-25)
6 Etappen mit zusätzlichen Kits oder Zubehör (+info Seiten 24-25)
6 fasi con packs o accessori opzionali (+info pagine 24-25)



OMNI ARENA



OMNI
C181-M7753

- ↑ 90,5 cm
- 126,1 cm
- ↻ 73 cm

* 5 stages with additional kits or accessories (+info pages 22-23)
 5 etapas con packs o accesorios adicionales (+info págs. 22-23)
 5 tapes avec des kits ou accessoires supplémentaires (+info pages 22-23)
 5 Etappen mit zusätzlichen Kits oder Zubehör (+info Seiten 22-23)
 5 fasi con packs o accessori opzionali (+info pagine 22-23)



OMNI XL
C191-M7753

- ↑ 90,5 cm
- 146,1 cm
- ↻ 82,5 cm

* 6 stages with additional kits or accessories (+info pages 24-25)
 6 etapas con packs o accesorios adicionales (+info págs. 24-25)
 6 tapes avec des kits ou accessoires supplémentaires (+info pages 24-25)
 6 Etappen mit zusätzlichen Kits oder Zubehör (+info Seiten 24-25)
 6 fasi con packs o accessori opzionali (+info pagine 24-25)

2 SIZES: 60x120 / 70x140 cm



633-181

C181-M7700 + WCO180-70
(pages 22-23)

(60 x 120 cm)



OMNI
C181-M7700

- ↑ 90,5 cm
- 126,1 cm
- ↻ 73 cm

* 5 stages with additional kits or accessories (+info pages 22-23)
5 etapas con packs o accesorios adicionales (+info págs. 22-23)
5 tapes avec des kits ou accessoires supplémentaires (+info pages 22-23)
5 Etappen mit zusätzlichen Kits oder Zubehör (+info Seiten 22-23)
5 fasi con packs o accessori opzionali (+info pagine 22-23)

(70 x 140 cm)



OMNI XL
C191-M7700

- ↑ 90,5 cm
- 146,1 cm
- ↻ 82,5 cm

* 6 stages with additional kits or accessories (+info pages 24-25)
6 etapas con packs o accesorios adicionales (+info págs. 24-25)
6 tapes avec des kits ou accessoires supplémentaires (+info pages 24-25)
6 Etappen mit zusätzlichen Kits oder Zubehör (+info Seiten 24-25)
6 fasi con packs o accessori opzionali (+info pagine 24-25)

OMNI WHITE



C181-M7755 + WJB180-M77
(pages 22-23)

633-055

B754-M7755

OMNI MINT



OMNI
C181-M7755

- ↑ 90,5 cm
- 126,1 cm
- ↻ 73 cm

* 5 stages with additional kits or accessories (+info pages 22-23)
 5 etapas con packs o accesorios adicionales (+info págs. 22-23)
 5 tapes avec des kits ou accessoires supplémentaires (+info pages 22-23)
 5 Etappen mit zusätzlichen Kits oder Zubehör (+info Seiten 22-23)
 5 fasi con packs o accessori opzionali (+info pagine 22-23)



OMNI XL
C191-M7755

- ↑ 90,5 cm
- 146,1 cm
- ↻ 82,5 cm

* 6 stages with additional kits or accessories (+info pages 24-25)
 6 etapas con packs o accesorios adicionales (+info págs. 24-25)
 6 tapes avec des kits ou accessoires supplémentaires (+info pages 24-25)
 6 Etappen mit zusätzlichen Kits oder Zubehör (+info Seiten 24-25)
 6 fasi con packs o accessori opzionali (+info pagine 24-25)



2 SIZES: 60x120 / 70x140 cm

633-178

C181-M7778

B754-M7778

OMNI GREY

(60 x 120 cm)



OMNI
C181-M7778

- ↑ 90,5 cm
- 126,1 cm
- ↻ 73 cm

* 5 stages with additional kits or accessories (+info pages 22-23)
5 etapas con packs o accesorios adicionales (+info págs. 22-23)
5 tapes avec des kits ou accessoires supplémentaires (+info pages 22-23)
5 Etappen mit zusätzlichen Kits oder Zubehör (+info Seiten 22-23)
5 fasi con packs o accessori opzionali (+info pagine 22-23)

(70 x 140 cm)



OMNI XL
C191-M7778

- ↑ 90,5 cm
- 146,1 cm
- ↻ 82,5 cm

* 6 stages with additional kits or accessories (+info pages 24-25)
6 etapas con packs o accesorios adicionales (+info págs. 24-25)
6 tapes avec des kits ou accessoires supplémentaires (+info pages 24-25)
6 Etappen mit zusätzlichen Kits oder Zubehör (+info Seiten 24-25)
6 fasi con packs o accessori opzionali (+info pagine 24-25)



C181

2in1



C181
60x120 cm

PACK **OMNI-K10**

3in1



C181

+



WCO180-70

PACK **OMNI-K11**

2in1



C181

+



606



607

PACK **OMNI-K12**

3in1



C181

+



WCO180-70



606

+



607

OMNI STAGES

2in1

2 STAGES



+



Cot
Cuna
Lit bébé
Babybett
Lettingo

Desk
Escritorio
Bureau
Schreibtisch
Scrivania

3in1

3 STAGES



+



+



Co-sleeping cot
Cuna de colecho
Lit cododo
Beistellbett
Lettingo fianco letto

Cot
Cuna
Lit bébé
Babybett
Lettingo

Desk
Escritorio
Bureau
Schreibtisch
Scrivania

PACK **OMNI-K13**

4in1



C181



WJB180-M77



606



607

PACK **OMNI-K14**

5in1



C181



WCO180-70



606



607



WJB180-M77

PACK **OMNI-K15**

4in1



C181



ZV60-120



606



607



WJB180-M77

PACK **OMNI-K16**

5in1



C181



WCO180-70



ZV60-120



606



607



WJB180-M77

OMNI STAGES

4in1

4 STAGES



Cot
Cuna
Lit bébé
Babybett
Lettino



Toddler bed
Camita
Lit cadet
Juniorbett
Lettino sponda junior



Couch
Sofá infantil
Canapé
Sofa
Divanetto



Desk
Escritorio
Bureau
Schreibtisch
Scrivanía

5in1

5 STAGES



Co-sleeping cot
Cuna de colecho
Lit cododo
Beistellbett
Lettino fianco letto



Cot
Cuna
Lit bébé
Babybett
Lettino



Toddler bed
Camita
Lit cadet
Juniorbett
Lettino sponda junior



Couch
Sofá infantil
Canapé
Sofa
Divanetto



Desk
Escritorio
Bureau
Schreibtisch
Scrivanía



C191

2in1



C191
70x140 cm

* Optional 4 wheels (page 26) | Opcional 4 ruedas (pág.26) | 4 roues supplémentaire (page 26)
4 Räder (seiten 26) | Opzionali 4 ruote (pag. 26)

PACK **OMNIXL-K10**

3in1



C191



WCO191-70

PACK **OMNIXL-K11**

2in1



C191



626



627

PACK **OMNIXL-K12**

3in1



C191



WCO191-70



626



627

OMNI XL STAGES

2in1

2 STAGES



Cot
Cuna
Lit bébé
Babybett
Letтино

Desk
Escritorio
Bureau
Schreibtisch
Scrivania

3in1

3 STAGES



Co-sleeping cot
Cuna de colecho
Lit cododo
Beistellbett
Letтино fianco letto

Cot
Cuna
Lit bébé
Babybett
Letтино

Desk
Escritorio
Bureau
Schreibtisch
Scrivania

PACK **OMNI XL-K13**

5in1



C191



WJB191-M77



626



627

PACK **OMNI XL-K14**

6in1



C191



WCO191-70



626



627



WJB191-M77

PACK **OMNI XL-K15**

5in1



C191



ZV70-140



626



627



WJB191-M77

PACK **OMNI XL-K16**

6in1



C191



WCO191-70



ZV70-140



626



627



WJB191-M77

OMNI XL STAGES

5in1

5 STAGES



Cot
Cuna
Lit bébé
Babybett
Letтино



Toddler bed
Camita
Lit cadet
Juniorbett
Letтино sponda junior



Couch
Sofá infantil
Canapé
Sofa
Divanetto



Montessori bed
Camita Montessori
Lit cadet Montessori
Montessori-Juniorbett
Letтино Montessori



Desk
Escritorio
Bureau
Schreibtisch
Scrivanía

6in1

6 STAGES



Co-sleeping cot
Cuna de colecho
Lit cododo
Beistellbett
Letтино fianco letto



Toddler bed
Camita
Lit cadet
Juniorbett
Letтино sponda junior



Desk
Escritorio
Bureau
Schreibtisch
Scrivanía



Cot
Cuna
Lit bébé
Babybett
Letтино



Couch
Sofá infantil
Canapé
Sofa
Divanetto



Montessori bed
Camita Montessori
Lit cadet Montessori
Montessori-Juniorbett
Letтино Montessori

CO-SLEEPER STAGE DETAILS | DETALLES ETAPA DE COLECHO

DÉTAILS ÉTAPE CODODO | *DETAILS BEISTELLBETT ETAPE* | DETTAGLI FASE FIANCO LETTO

OMNI

Ref. C181

60 X 120 cm

5 heights / alturas**

62,7 cm
56,3 cm
49,9 cm
43,5 cm
40,3 cm

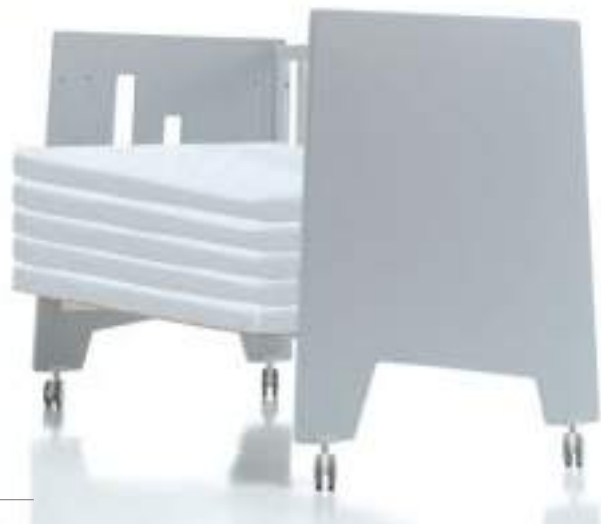

OMNI XL***

Ref. C191

70 X 140 cm

5 heights / alturas**

62,7 cm
56,3 cm
49,9 cm
43,5 cm
40,3 cm



** Height with mattress included | Altura con colchón incluido
Hauteur du couchage, matelas compris | Höhenverstellung mit Matratze | Altezza con materasso incluso

ACCESSORIES | ACCESORIOS | ACCESSOIRES | ZUBEHÖR | ACCESSORI

OPTIONS | OPCIONES | OPTIONS OPTIONE | OPZIONI



Mattress extension outside
Suplemento colchón en posición exterior
Rallonge de matelas à l'extérieur
Matratzenverbreiterung außen
Materassino supplementare montato esternamente



Mattress extension inside
Suplemento colchón en posición interior
Rallonge de matelas à l'intérieur
Matratzenverbreiterung innen
Materassino supplementare montato internamente

OMNI XL*** C191

Optional 4 wheels with brake
4 ruedas con freno opcional
4 roues avec frein supplémentaire
4 Räder mit Bremse
Opzionali 4 ruote



Ref. RU -70



Straps with velcro
Detalle de cintas con velcro
Sangles à scratch
Klett-Gurten
Ditaglio cinghie con velcro



Fastening straps included in the co-sleeping kit
Cintas anclaje incluidas en kit colecho
Sangles de fixation incluses dans le kit
Befestigungsgurten im Beistellbett-Kit inbegriffen
Cinghie ancoraggio incluse nel kit



Fastening straps attached to the bed
Detalle sistema sujeción unido a la cama
Système de fixation au lit
Befestigungssystem am Bett
Ditaglio sistema ancoraggio letto



*** Height with wheels | Altura con ruedas
Hauteur avec roues | Höhe mit rädern
Altezza con ruote

5 heights / alturas***

70,7 cm
64,3 cm
57,9 cm
51,5 cm
48,3 cm

Ref. WCO180-70 / WCO191-70

Co-sleeping pack | Kit colecho | Pack cododo | Beistellbett-Set | Set fianco letto



OMNI
60 X 120 cm
WCO 180-70

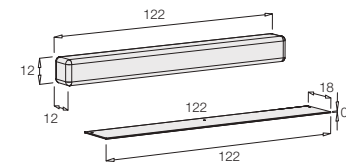

OMNI XL
70 X 140 cm
WCO 191-70

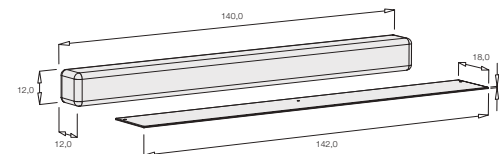

Includes:
Co-sleeping extension board
Fastening straps
Foam mattress extension
Hardware

Incluye:
Tablero extensión colecho
Set de cintas de sujeción
Suplemento colchón espuma
Herrajes

Inclut:
Planche pour extension cododo
Sangles de fixation
Rallonge de matelas
Visserie

Beinhaltet:
Verlängerungsseite für Beistellbett
Befestigungsgurten
Matratzenverbreiterung
Schraubensatz

Include:
Tavoletta estensione base lettino
Set cinghie ancoraggio
Materassino supplementare gomma piuma
Ferramenta

2 POSITIONS | 2 POSICIONES
2 POSITIONS | 2 POSITIONEN | 2 POSIZIONI

Ref. WJB180-M77 / WJB191-M77

Safety guard | Barrera cuna | Barrière junior | Absturzsicherung | Sponda junior



OMNI Ref. WJB 180-M77



OMNI XL Ref. WJB 191-M77

2 POSITIONS | 2 POSICIONES
2 POSITIONS | 2 POSITIONEN | 2 POSIZIONI



OMNI
60 X 120 cm
WJB 180-M77

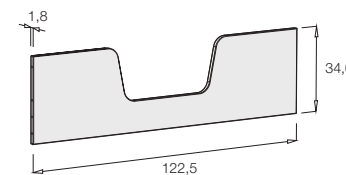

OMNI XL
70 X 140 cm
WJB 191-M77

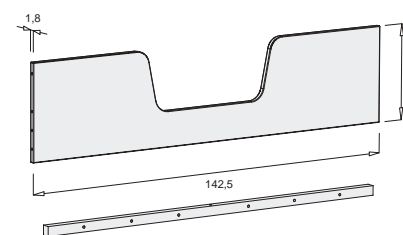

Includes:
Safety guard / Base for couch
Hardware

It can be used for 2 stages: firstly, to transform the cot into a toddler bed and, subsequently, by turning it around, into a couch.

Incluye:
Barrera junior / base sofá
Herrajes

Sirve para transformar la cuna en 2 etapas, primero como camita junior y después, dándole la vuelta, como sofá infantil.

Inclut:
Barrière junior / base canapé
Visserie
Le pack permet de transformer le lit en 2 étapes: d'abord en tant que lit cadet et, ensuite, en canapé.

Beinhaltet:
Absturzsicherung / Boden für Sofa
Schraubensatz
Es ermöglicht, das Babybett zu einem Juniorbett und später zu einem sofa umzubauen.

Include:
Sponda junior / base divanetto
Ferramenta
Serve per trasformare il lettino in 2 fasi: prima in lettino aperto, poi in divanetto.

2 junior safety guards can be installed, one on each side
Se pueden colocar 2 barreras adicionales, una en cada lado
2 barrières junior supplémentaires peuvent être installées, une sur chaque côté
2 zusätzliche Absturzsicherungen können angebracht werden, eine auf jede Seite
Si possono montare 2 sponde junior aggiuntive, una per ogni lato

STAGE
1
0-1 years

Co-sleeping cot | Cuna de colecho
Lit bébé cododo | *Beistellbett* | Lettino fianco letto



STAGE
2
1-2 years

Cot | Cuna
Lit bébé | *Babybett* | Lettino

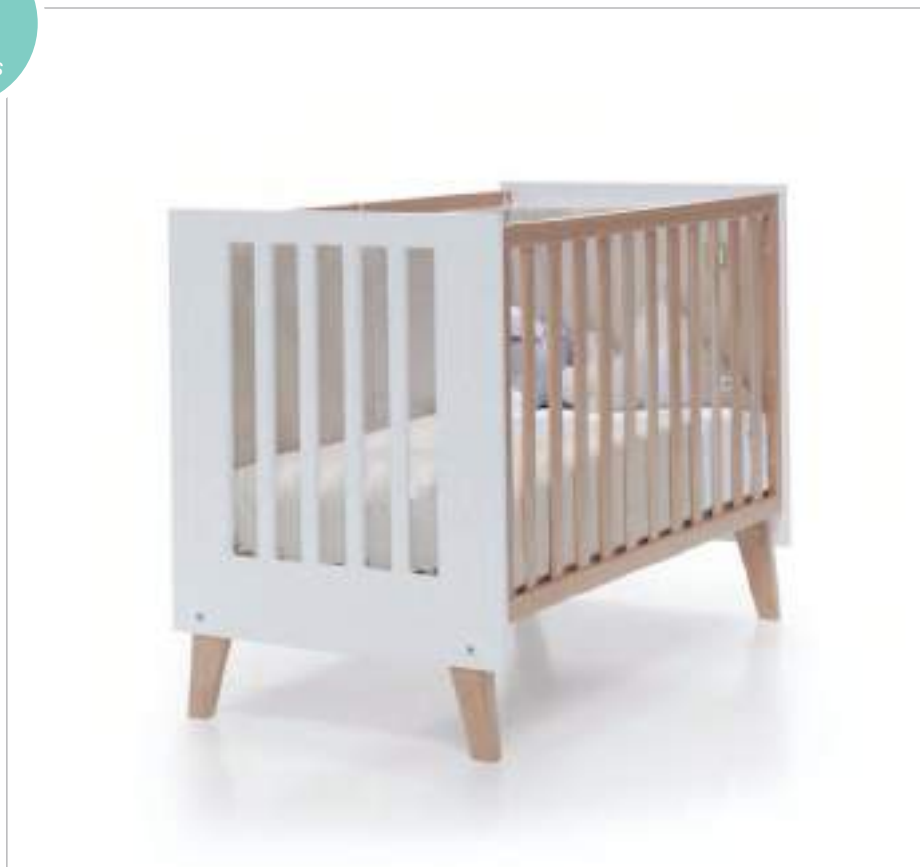

* Additional kit ref. WCO180-70 (page 34)

STAGE
3
2-5 years

Toddler bed | Camita infantil
Lit cadet | *Juniorbett* | Lettino sponda junior



* Additional kit ref. WCO181-70 (page 34)

STAGE
4
5-14 years

Desk | Escritorio infantil
Bureau | *Schreibtisch* | Scrivania



* 4 stages with additional kits or accessories | 4 etapas con packs o accesorios adicionales
4 étapes avec des kits ou accessoires supplémentaires | 4 Etappen mit zusätzlichen Kits oder Zubehör | 4 fasi con packs o accessori opzionali



60x120 cm



NEXO

90,3 x 126,1 x 68,8 cm



* Additional kit ref. WCO180-M77 (page 34)



NEXO

C187-M7700 + WJB180-M77
(pages 32-33)

633-194

B737-M9477



NEXO WHITE



Co-sleeping cot | Cuna de colecho
Lit bébé cododo | *Beistellbett*
Lettino fianco letto
*Additional kit WCO180-70 (p. 34)



Cot 60x120 | Cuna 60x120
Lit bébé 60x120 | *Babybett 60x120*
Lettino 60x120



Toddler bed | *Camita infantil*
Lit cadet | *Juniorbett*
Lettino sponda junior
*Additional kit WJB180-M77 (p. 34)



Desk | *Escritorio infantil*
Bureau | *Schreibtisch*
Scrivanía
*Additional kit WJB180-M77 (p. 34)



60x120 cm



633-114

B751-M7700

NEXOR

C187R-M7795 + WJB180-M77
(pages 32-33)



Co-sleeping cot | Cuna de colecho
Lit bébé cododo | Beistellbett
Lettino fianco letto
*Additional kit WCO180-70 (p. 34)



Cot 60x120 | Cuna 60x120
Lit bébé 60x120 | Babybett 60x120
Lettino 60x120



Toddler bed | Camita infantil
Lit cadet | Juniorbett
Lettino sponda junior
*Additional kit WJB180-M77 (p. 34)



Desk | Escritorio infantil
Bureau | Schreibtisch
Scrivanja
*Additional kit WJB180-M77 (p. 34)



C187/C187R

2 in 1



**C187
NEXO**
60x120 cm



**C187R
NEXOR**
60x120 cm

PACK **NEXO-K10/NEXOR-K10**

3 in 1



C187-M7700 (NEXO-K10)
C187R-M7795 (NEXOR-K10)

+



WCO180-70

PACK **NEXO-K11/NEXOR-K11**

2 in 1



C187-M7700 (NEXO-K10)
C187R-M7795 (NEXOR-K10)

+



606



607

PACK **NEXO-K12/NEXOR-K12**

3 in 1



C187-M7700 (NEXO-K10)
C187R-M7795 (NEXOR-K10)

+



WCO180-70



606

+



607

NEXO STAGES

2 in 1

2 STAGES



**Cot
Cuna**
Lit bébé
Babybett
Lettino

+



**Desk
Escritorio**
Bureau
Schreibtisch
Scrivania

3 in 1

3 STAGES



**Co-sleeping cot
Cuna de colecho**
Lit cododo
Beistellbett
Lettino fianco letto

+



**Cot
Cuna**
Lit bébé
Babybett
Lettino

+



**Desk
Escritorio**
Bureau
Schreibtisch
Scrivania

PACK NEXO-K13/NEXOR-K13

3in1



PACK NEXO-K14/NEXOR-K14

4in1



PACK NEXO-K15/NEXOR-K15

3in1



PACK NEXO-K16/NEXOR-K16

4in1



NEXO STAGES

3in1

3 STAGES



Cot
Cuna
Lit bébé
Babybett
Lettino

Toddler bed
Camita
Lit cadet
Juniorbett
Lettino sponda junior

Desk
Escritorio
Bureau
Schreibtisch
Scrivania

4in1

4 STAGES

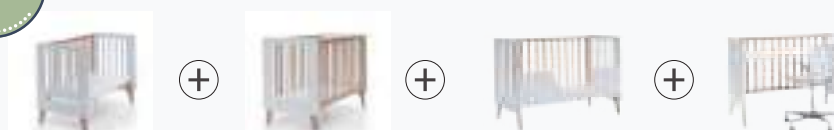

Co-sleeping cot
Cuna de colecho
Lit cododo
Beistellbett
Lettino fianco letto

Cot
Cuna
Lit bébé
Babybett
Lettino

Toddler bed
Camita
Lit cadet
Juniorbett
Lettino sponda junior

Desk
Escritorio
Bureau
Schreibtisch
Scrivania

CO-SLEEPER STAGE DETAILS | DETALLES ETAPA DE COLECHO
DÉTAILS ÉTAPE CODODO | DETAILS BEISTELLBETT ETAPE
DETTAGLI FASE FIANCO LETTO

Ref. C187
 Ref. C187R

5 heights / alturas**

62,7 cm
 56,3 cm
 49,9 cm
 43,5 cm
 40,3 cm



** Height with mattress included | Altura con colchón incluido
 Hauteur du couchage, matelas compris | Höhenverstellung mit Matratze | Altezza con materasso incluso



Ref. WCO180-70

Co-sleeping pack | Kit colecho
 Pack cododo | Beistellbett-Set | Set fianco letto



Mattress extension outside
 Suplemento colchón en posición exterior
 Rallonge de matelas à l'extérieur
 Matratzenverbreiterung außen
 Materassino supplementare montato esternamente



Mattress extension inside
 Suplemento colchón en posición interior
 Rallonge de matelas à l'intérieur
 Matratzenverbreiterung innen
 Materassino supplementare montato internamente



Straps with velcro
 Detalle de cintas con velcro
 Sangles à scratch
 Klett-Gurten
 Dittaglio cinghie con velcro



2 positions for the mattress and mattress extension
 2 posiciones de colchón y suplemento de colchón
 2 positions du matelas et du rallonge de matelas
 2 Positionen der Matratze und Matratzenverbreiterung
 2 posizioni materasso e materassino supplementare



Ref. WCO180-70

Fastening straps included in the co-sleeping kit
 Cintas anclaje incluidas en kit colecho
 Sangles de fixation incluses dans le kit
 Befestigungsgurten im Beistellbett-Kit inbegriffen
 Cinghie ancoraggio incluse nel kit



Fastening straps attached to the bed
 Detalle sistema sujeción unido a la cama
 Système de fixation au lit
 Befestigungssystem am Bett
 Dittaglio sistema ancoraggio letto

2 OPTIONS | 2 OPCIONES
2 OPTIONS | 2 OPTIONEN
2 OPZIONI

1 Co-sleeping pack | Kit colecho | Pack cododo
 Beistellbett-Set | Set fianco letto

Ref. WCO180-70

Includes:
 Co-sleeping extension board
 Fastening straps
 Foam mattress extension
 Hardware

Incluye:
 Tablero extensión colecho
 Set de cintas de sujeción
 Suplemento colchón espuma
 Herrajes

Inclut:
 Planche pour extension cododo
 Sangles de fixation
 Rallonge de matelas
 Visserie

Beinhaltet:
 Verlängerungsseite für Beistellbett
 Befestigungsgurten
 Matratzenverbreiterung
 Schraubensatz

Include:
 Tavoletta estensione base lettino
 Set cinghie ancoraggio
 Materassino supplementare gomma piuma
 Ferramenta

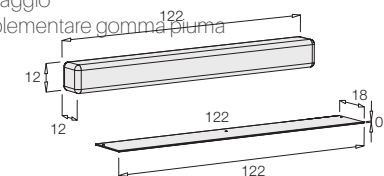

2 Safety guard | Barrera cuna 2 posiciones
 Barrière junior | Absturzsicherung | Sponda junior

Ref. WJB180-M77

Includes:
 Safety guard / Base for couch
 Hardware

It can be used for 2 stages: firstly, to transform the cot into a toddler bed and, subsequently, by turning it around, into a couch.

Incluye:
 Barrera junior / base sofá
 Herrajes

Sirve para transformar la cuna en 2 etapas, primero como camita junior y después, dándole la vuelta, como sofá infantil.

Inclut:
 Barrière junior / base canapé
 Visserie

Le pack permet de transformer le lit en 2 étapes: d'abord en tant que lit cadet et, ensuite, en canapé.

Beinhaltet:
 Absturzsicherung / Boden für Sofa
 Schraubensatz

Es ermöglicht, das Babybett zu einem Juniorbett und später zu einem sofa umzubauen.

Include:
 Sponda junior / base divanetto
 Ferramenta

Serve per trasformare il lettino in 2 fasi: prima in lettino aperto, poi in divanetto.

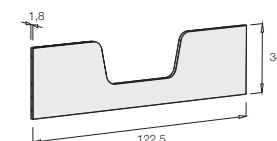

MONTESORI



MONTESORI BEDS | CAMAS MONTESORI
LITS MONTESORI | *MONTESORI-BETTEN* | LETTI MONTESORI

8 MONTESSORI TEXTILES | 8 TEXTILES MONTESSORI

8 TEXTILES MONTESSORI | 8 MONTESSORI TEXTILIEN | 8 COORDINATI TESSILI MONTESSORI



*Additional safety guard
ref. JBJ140-M77(page 46)

HOMY GALAXY
70x140 / 80x200 cm



HOMY MARE XL
80x200 cm



HOMY MARE
70x140 cm



HOMY MINT
70x140 / 80x200 cm



HOMY INDIANA BLU
70x140 / 80x200 cm



HOMY INDIANA ROSA
70x140 / 80x200 cm

*Additional safety guard ref. JBJ140-M77(page 46)



*Additional safety guard
ref. JBJ140-M77(page 46)

HOMY VENTO
70x140 / 80x200 cm



HOMY CAREZZA
70x140 / 80x200 cm



HOMY ARENA
70x140 / 80x200 cm

MONTESORI HOMY

2 SIZES: 70x140 / 80x200 cm

MATTE
FINISH



HOMY (70 x 140)
140,5 x 152,5 x 82 cm
↑ → ↻

HOMY XL (80 x 200)
162,5 x 208 x 101 cm
↑ → ↻



HOMY
Ref. NA140-M70



HOMY XL
Ref. NA200-M70



SAFETY GUARD
Ref. JBJ140-M77



Ref. WCH-70
⌀ 12 cm → 70 cm



Ref. WCH-90
⌀ 12 cm → 90 cm



Ref. WCH-140
⌀ 12 cm → 140 cm

8 MONTESSORI TEXTILES | 8 TEXTILES MONTESSORI

8 TEXTILES MONTESSORI | 8 MONTESSORI TEXTILIEN | 8 COORDINATI TESSILI MONTESSORI



INDY GALAXY

*Additional safety guard ref. JBJ140-M77(page 46)



INDY INDIANA ROSA



INDY MARE



INDY MINT



INDY INDIANA BLU

*Additional safety guard ref. JBJ140-M77(page 46)



INDY VENTO



INDY CAREZZA



INDY ARENA

MONTESORI INDY

70x140 cm

MATTE
FINISH



INDY (70 x 140)
143,5 x 148 x 75 cm
↑ → ↻



INDY
Ref. NC141-M70













SAFETY GUARD
Ref. JBJ140-M77

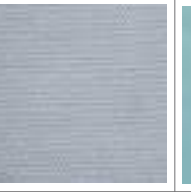

Ref. WCH-70
⊙ 12 cm → 70 cm

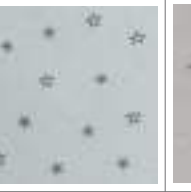

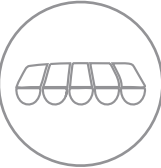
Ref. WCH-140
⊙ 12 cm → 140 cm

										
		MINT 055	INDIANA BLU 111	INDIANA ROSA 112	GALAXY 114	ARENA 153	CAREZZA 178	MARE 181	MARE XL 181	VENTO 194
Canopy for Montessori beds Toldo textil para cama Montessori Ciel de lit pour lits Montessori Bethimmel für Montessori-Betten Tendalino per letto Montessori	 HOMY 70 x 140	6140NA-055	6140NA-111	6140NA-112	6140NA-114	6140NA-153	6140NA-178	6140NA-181	-----	6140NA-194
	 HOMY XL 90 x 200	6200NA-055	6200NA-111	6200NA-112	6200NA-114	6200NA-153	6200NA-178	-----	6200NA-181	6200NA-194
	 INDY 70 x 140	6141NC-055	6141NC-111	6141NC-112	6141NC-114	6141NC-153	6141NC-178	6141NC-181	-----	6141NC-194

		MINT 055	INDIANA BLU 111	INDIANA ROSA 112	GALAXY 114	ARENA 153	CAREZZA 178	MARE 181	VENTO 194
Duvet cover (with duvet) Nordico (con relleno) Housse et couette Bettbezug (mit Decke) Plumino nordico (con imbottitura)	 626 70 x 140	626-055	626-111	626-112	626-114	626-153	626-178	626-181	626-194
	 636 80/90 x 200	636-055	636-111	636-112	636-114	636-153	636-178	636-181	636-194
Duvet cover (without duvet) Funda nordica (sin relleno) Housse pour couette Bettbezug (ohne Decke) Sacco nordico (senza imbottitura)	 626F 70 x 140 (105 x 165 cm)	626F-055	626F-111	626F-112	626F-114	626F-153	626F-178	626F-181	626F-194
	 636F 80/90 x 200 (150 x 220 cm)	636F-055	636F-111	636F-112	636F-114	636F-153	636F-178	636F-181	636F-194

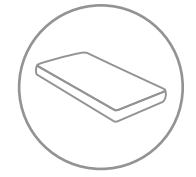
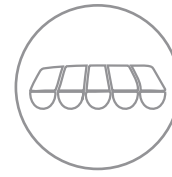

BABY
70x140



Reference Referencia Référence Referenz Riferimento	Frame Estructura Structure Bettgestell Struttura	Canopy Toldo Ciel de lit Betthimmel Tendalino	Duvet cover (with duvet) Nórdico (con relleno) Housse et couette Bettbezug (mit Decke) Piumino nordico (con imbottitura)	Memory foam mattress Colchón viscoelástica Matelas viscoélastique Matratze aus Viscoschaum Materasso memory foam
HOMY-10	●	●		
HOMY-11	●		●	
HOMY-12	●		●	●
HOMY-13	●	●	●	
HOMY-14	●	●	●	●



INDY-10	●	●		
INDY-11	●		●	
INDY-12	●		●	●
INDY-13	●	●	●	
INDY-14	●	●	●	●

JUNIOR
90x200



Reference Referencia Référence Referenz Riferimento	Frame Estructura Structure Bettgestell Struttura	Canopy Toldo Ciel de lit Betthimmel Tendalino	Duvet cover (with duvet) Nórdico (con relleno) Housse et couette Bettbezug (mit Decke) Piumino nordico (con imbottitura)	Memory foam mattress Colchón viscoelástica Matelas viscoélastique Matratze aus Viscoschaum Materasso memory foam
HOMY XL-20	●	●		
HOMY XL-21	●		●	
HOMY XL-22	●		●	●
HOMY XL-23	●	●	●	
HOMY XL-24	●	●	●	●

MONTESSORI SCALA

LEARNING TOWER | TORRE DE APRENDIZAJE
TOUR D'APPRENTISSAGE | LERNTURM | TORRE DI APPRENDIMENTO

Ref. NT100-M77

- 3 height adjustments
 - Allows the kid to reach higher places alone, thus fostering his/her autonomy
 - Side and back anti-tipping system
 - Steps with non-slip surface
 - Light, only 9 kg, easy to carry
 - Use from 12 months to 6/7 years
-
- Regulable en 3 alturas.
 - Con ella el bebé puede alcanzar por sí solo lugares más altos, dándole mayor autonomía
 - Sistema antivuelco lateral y trasero
 - Escalones con superficie antideslizante
 - Ligera, sólo 9 kg, de fácil transporte
 - Uso desde 12 meses hasta 6/7 años
-
- Réglable sur 3 hauteurs
 - Permet l'enfant de se place au même niveau que les adultes et vous aide à développer son autonomie
 - Système anti-renversement sur les côtés et l'arrière
 - Marches avec surface anti-glisse
 - Légère, seulement 9 kg, facile à transporter
 - Utilisation entre 12 mois et 6/7 ans
-
- 3-fach höhenverstellbar
 - Fördert die Selbstständigkeit des Kindes
 - Anti-Kipp System hinten und seitlich
 - Treppenstufen mit Anti-Rutsch Oberfläche
 - Leicht, nur 9 kg, leicht zu transportieren
 - Verwendung zwischen 12 Monate und 6/7 Jahre
-
- Regolabile su 3 altezze
 - Grazie a essa il bimbo può interagire più facilmente con gli adulti, ponendosi alla stessa altezza
 - Sistema antiribaltamento laterale e posteriore
 - Gradini con superficie antiscivolo
 - Leggera, solo 9 kg, facilmente trasportabile
 - Uso dai 12 mesi ai 6/7 anni



Close-up of steps
Detalle escalones
Vue rapprochée des marches
Detallansicht der Stufen
Dettaglio scalini



NT100-M77

SIZES | MEDIDAS

MESURES | MAßE | MISURE

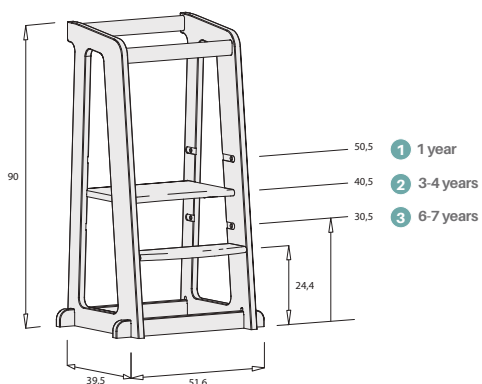

Ref. NW 120-M77

- Clothes stand with easily accessible hanging rod
- Low seat so the kid can learn to get dressed without assistance
- Toy storage unit, with anti-pinch function cover
- 2-height adjustable hanging rod

- Armario colgador de baja altura y fácil acceso
- Asiento baja altura, para que el niño/a aprenda a vestirse solo/a
- Baúl para guardar juguetes, con tapa sistema anti-atrapamiento
- Barra de colgar regulable en 2 alturas

- Armoire avec penderie facilement accessible
- Siège à la hauteur de l'enfant afin qu'il puisse apprendre à s'habiller tout seul
- Coffre à jouets, avec système anti-pincement
- Barre de suspension réglable sur 2 hauteurs

- Schrank mit erreichbarer Kleiderstange
- Bodennahe Sitzfläche, damit das Kind lernen kann, sich allein anzuziehen
- Aufbewahrungskiste - Deckel mit Einklemmschutz
- 2-fach höhenverstellbare Kleiderstange

- Armadio appendiabiti de piccole dimensionie facile accesso
- Sedile basso affinché il bimbo/a apprenda a vestirsi da solo/a
- Baule per riporre i giocattoli, con chiusura antischacciamento
- Barra appendiabiti regolabile su 2 altezze

SIZES | MEDIDAS
MESURES | MAßE | MISURE

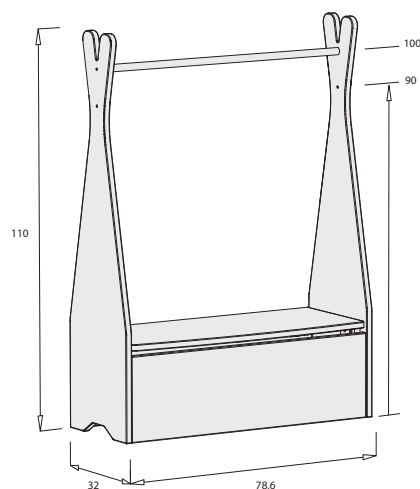

1 Clothes stand | Armario colgador
Penderie | Schrank | Armadio appendiabiti



2 Storage unit | Baúl | Coffre
Aufbewahrungskiste | Bauletto



3 Bank | Asiento
Siège | Sitz | Sedile



3in1



NW120-M77

2 POSITIONS | 2 POSICIONES
2 POSITIONS | 2 POSITIONEN | 2 POSIZIONI

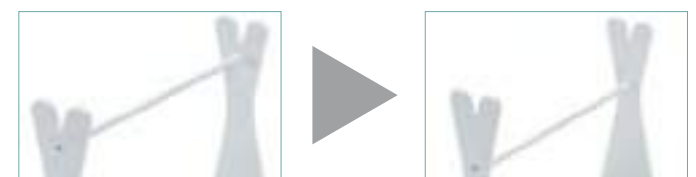



ND121

- Montessori shelf
- Designed to display books and toys at eye level so the baby can choose among the materials presented
- Easily accessible
- The front can be customised in 6 colours

- Estantería Montessori
- Diseñada para colocar libros y accesorios de frente y facilitar al niño su elección
- Accesible desde la altura del bebé
- Frontal personalizable en 6 colores

- Étagère Montessori
- Conçue à hauteur d'enfant pour qu'il puisse choisir les livres, qui seront présentés de face
- Accessible au bébé
- Partie frontale personnalisable - 6 couleurs

- Montessori Bücherregal
- Es ermuntert Kinder durch selbstständiges Auswählen der Bücher zum Lesen
- Leicht zu erreichen für Babys
- Vorderteil in 6 Farben erhältlich

- Mensola Montessori
- Disegnata per riporre libri ed accessori ad altezza bimbo e facilitarli l'accesso agli stessi
- Accessibile a bimbi/e di tutte le altezze
- Frontale personalizzabile in 6 colori



ND121-M7778

SIZES | MEDIDAS MESURES | MAßE | MISURE

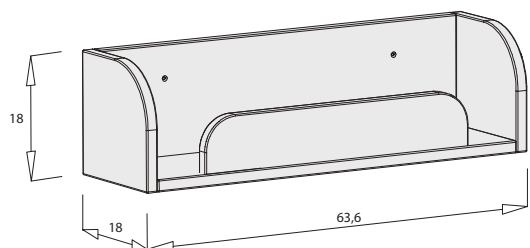







COLOURS | COLORES | COULEURS | FARBEN | COLORI



ND121-M7778

ND121

↑ 18 cm → 63,6 cm ↻ 18 cm

- | | | |
|---|---|---|
|  ND121-M7700 |  ND121-M7752 |  ND121-M7755 |
|  ND121-M7751 |  ND121-M7753 |  ND121-M7778 |

NE122-M77

- Montessori mirror
- 2 positions: horizontal (0 to 4-5 years) and vertical (from 5 years)
- Helps the baby discover its own image and surroundings
- 3-height adjustable bar to grow with the baby
- Unbreakable methacrylate mirror

- Espejo infantil Montessori
- 2 posiciones: horizontal (0 a 4-5 años) y vertical (a partir de 5 años)
- Ayuda al bebé a descubrir su propia imagen y entorno
- Barra regulable en 3 alturas para adaptarse al crecimiento del bebé
- Espejo de metacrilato plástico irrompible

- Miroir Montessori
- 2 positions: horizontal (0 à 4-5 ans) et vertical (à partir de 5 ans)
- Bébé découvrira son image et pourra regarder tout ce qui se passe autour de lui
- Barre de brachiation réglable sur 3 étapes d'après le développement du bébé
- Miroir en méthacrylate incassable

- Montessori Spiegel
- 2 Positionen: horizontal (0 bis 4-5 Jahre) und vertikal (ab 5 Jahre)
- Das Baby wird sein eigenes Gesicht erkennen und die Welt aus einer andere Perspektive sehen können
- 3-fach höhenverstellbare Haltestange
- Unzerbrechlicher Spiegel aus Methacrylat

- Specchio Montessori
- 2 posizioni: orizzontale (da 0 a 4-5 anni) e verticale (dai 5 anni in su)
- Aiutail bimbo a scoprire la propria immagine e l'ambiente che lo circonda
- Barra posizionabile su 3 altezze, per adattarsi alla crescita del bebé
- Specchio in metacrilato infrangibile

SIZES | MEDIDAS MESURES | MAßE | MISURE

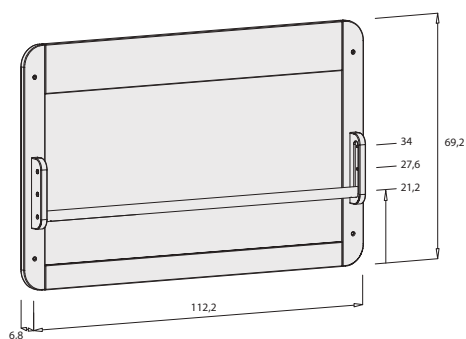

1

Horizontal position | Posición horizontal | Position horizontal | Positionen horizontal | Posizioni orizzontale



2

Vertical position | Posición vertical | Position vertical | Positionen vertikal | Posizioni verticale



MONTESSORI SAFETY GUARD



Safety guard
Barrera Montessori
Barrière junior
Absturzicherung
Sponda junior

Ref. JBJ140-M77

- Safety guard for Montessori bed
- Compatible with all Alondra beds with slatted bed base
- Velcro fastening
- Fixed (not movable)
- It can be installed in the middle of the bed or on either corner

- Barrera de seguridad para cama Montessori
- Compatible con todo tipo de camas con somier de lamas de Alondra
- Fijación con velcros
- Posición fija (no abatible)
- Se puede colocar centrada o hacia una u otra esquina.

- Barrière pour lit Montessori
- Compatible avec tous les lits Alondra beds avec sommier à lattes
- Fixation en velcro
- Fixe (pas mobile)
- Possibilité de l'installer au centre du lit ou sur les côtés

- Gitter für Montessori Bett
- Kompatibel für alle Alondra Betten, die mit Lattenrost ausgestattet sind
- Befestigung mit Klettbandern
- Fest (nicht mobil)
- Es kann an der Mitte oder an den Seiten angebracht werden

- Sponda junior Montessori
- Compatibile con tutti i lettini con rete a doghe di Alondra
- Sistema di ancoraggio con velcro
- Posizione fissa: non abbattibile
- Si può montare in posizione centrale o laterale

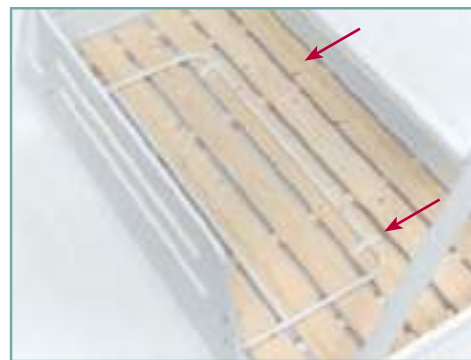

Attachment straps | Sistema de colocación | Système de fixation | Befestigungssystem | Modalità di ancoraggio



Back view | Vista trasera | Vue arrière
Rückwärtige Ansicht | Vista posteriore

SIZES | MEDIDAS MESURES | MAßE | MISURE

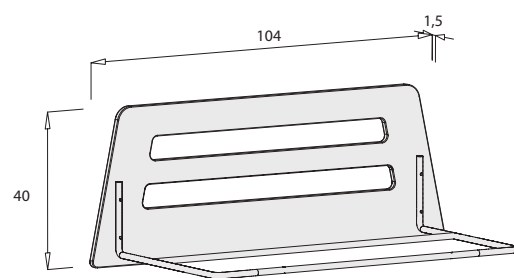

NC141-M70 + JBJ140-M77



KONVERS

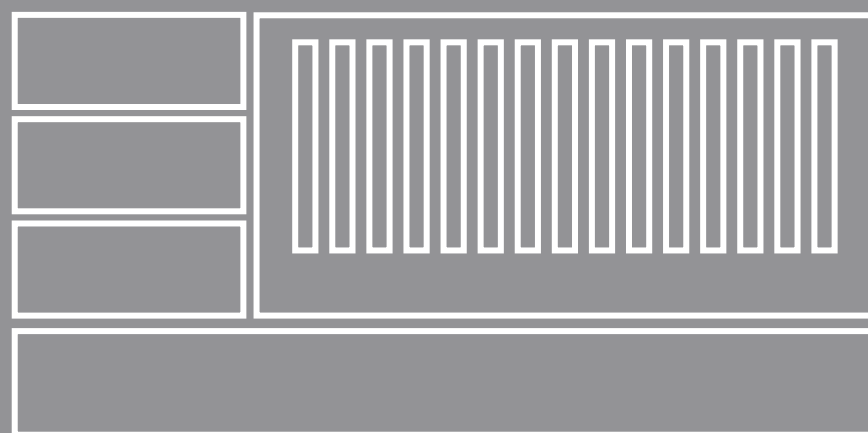

CONVERTIBLE CRIBS | CUNAS CONVERTIBLES | LITS BÉBÉ ÉVOLUTIFS
VERWANDELBARE BABYBETTEN | LETTINI TRASFORMABILI



K374-M7700 JUST BUBBLE **WHITE**



K374-M7751 JUST BUBBLE **CIELO**



K374-M7752 JUST BUBBLE **CORAL**



K374-M7753 JUST BUBBLE **ARENA**



K374-M7778 JUST BUBBLE **GREY**

2 STAGES | 2 ETAPAS | 2 ÉTAPES | 2 ETAPPEN | 2 FASI



BABY 0-3 years
Convertible crib | Cuna convertible
Lit bébé évolutif | Verwandelbares Babybett
Lettino trasformabile



J370G-M7700 / J370M-M7700 +info page xx



JUNIOR +3 years
Convertible crib as bedroom | Cuna convertible desmontada como habitación
Lit bébé évolutif transformé en chambre | Verwandelbares Babybett als Jugendzimmer
Lettino trasformabile montato a cameretta

101,5 x 205,6 x 120 cm

60x120
90x200

MATTE
FINISH



K374-M7755
60 x 120 cm » 90 x 200 cm

101,5 x 173,2 x 65,4 cm
↑ → ↻

JUST BUBBLE MINT



K376-M7700

JUST EVEN **WHITE**



K376-M7751

JUST EVEN **CIELO**



K376-M7752

JUST EVEN **CORAL**



K376-M7753

JUST EVEN **ARENA**



K376-M7778

JUST EVEN **GREY**

2 STAGES | 2 ETAPAS | 2 ÉTAPES | 2 ETAPPEN | 2 FASI

BABY
0-3
years



Convertible crib | Cuna convertible
Lit bébé évolutif | Verwandelbares Babybett
Letino trasformabile



J370G-M7700 / J370M-M7700 +info page xx

Optional drawers | Cajones adicionales
Tiroirs additionnels | Zusätzliche Schubladen
Cassetti aggiuntivi

JUNIOR
+3
years



101,5 x 205,6 x 120 cm



Convertible crib as bedroom | Cuna convertible desmontada como habitación
Lit bébé évolutif transformé en chambre | Verwandelbares Babybett als Jugendzimmer
Letino trasformabile montato a cameretta

60x120
90x200

MATTE
FINISH



JUST EVEN MARE

K376-M7781
60 x 120 cm » 90 x 200 cm

101,5 x 173,2 x 65,4 cm
ⓘ Ⓜ Ⓡ



K379-M7700

JUST JOY **WHITE**



K379-M7778

JUST JOY **GREY**



K379-M7779

JUST JOY **ETNIK**



K379-M7781

JUST JOY **MARE**



K379-M7782

JUST JOY **ROSE**

2 STAGES | 2 ETAPAS | 2 ÉTAPES | 2 ETAPPEN | 2 FASI

BABY
0-3
years



Convertible crib | Cuna convertible
Lit bébé évolutif | Verwandelbares Babybett
Letino trasformabile



J370G-M7700 / J370M-M7700 +info page xx

JUNIOR
+3
years



101,5 x 205,6 x 120 cm

Optional drawers | Cajones adicionales
Tiroirs additionnels | Zusätzliche Schubladen
Cassetti aggiuntivi

Convertible crib as bedroom | Cuna convertibile desmontada como habitación
Lit bébé évolutif transformé en chambre | Verwandelbares Babybett als Jugendzimmer
Letino trasformabile montato a cameretta

60x120
90x200

MATTE
FINISH



K379-M7779
60x 120 cm » 90x200 cm

101,5 x 173,2 x 65,4 cm
↑ → ↻

JUST JOY ETNIK



Bed guard & stairs - toybox see page 68 | Barandilla junior y escalera-juguetero en la página 68
Barrière junior et escalier - coffre à jouets voir page 68 | Gitter Junior und Treppe - Spielzeugkiste finden Sie auf der Seite 68
Sponda junior e scaletta portagiochi a pagina 68



K554C-M7700
Drawers | Cajones inferiores
Tiroirs | Schubladen | Cassettoni
K554N-M7700
Trundle bed | Cama nido
Lit gigogne | Ausziehbett | Letto estraibile

SERO BUBBLE **WHITE**



K554C-M7751
Drawers | Cajones inferiores
Tiroirs | Schubladen | Cassettoni
K554N-M7751
Trundle bed | Cama nido
Lit gigogne | Ausziehbett | Letto estraibile

SERO BUBBLE **CIELO**



K554C-M7752
Drawers | Cajones inferiores
Tiroirs | Schubladen | Cassettoni
K554N-M7752
Trundle bed | Cama nido
Lit gigogne | Ausziehbett | Letto estraibile

SERO BUBBLE **CORAL**



K554C-M7753
Drawers | Cajones inferiores
Tiroirs | Schubladen | Cassettoni
K554N-M7753
Trundle bed | Cama nido
Lit gigogne | Ausziehbett | Letto estraibile

SERO BUBBLE **ARENA**



K554C-M7755
Drawers | Cajones inferiores
Tiroirs | Schubladen | Cassettoni
K554N-M7755
Trundle bed | Cama nido
Lit gigogne | Ausziehbett | Letto estraibile

SERO BUBBLE **MINT**

3 STAGES | 3 ETAPAS | 3 ÉTAPES | 3 ETAPPEN | 3 FASI



Convertible crib | Cuna convertible
Lit bébé évolutif | Verwandelbares Babybett
Lettino trasformabile



With additional modules
Con módulos adicionales
Avec des modules supplémentaires
Mit Zusatzmodulen
Con moduli aggiuntivi



Convertible crib as bedroom
Cuna convertible desmontada como habitación
Lit bébé évolutif transformé en chambre
Verwandelbares Babybett als Jugendzimmer
Lettino trasformabile montato a cameretta

SERO BUBBLE

70x140
90x200

MATTE
FINISH



K554C-M7778
Drawers | Cajones inferiores
Tiroirs | Schubladen | Cassetoni

K554N-M7778
Trundle bed | Cama nido
Lit gigogne | Ausziehbett | Letto estraibile

105,5 x 206,4 x 102 cm
↑ → ↻

70 x 140 cm » 90 x 200 cm

SERO BUBBLE GREY



Bed guard & stairs - toybox see page 68 | Barandilla junior y escalera-juguetero en la página 68
Barrière junior et escalier - coffre à jouets voir page 68 | Gitter Junior und Treppe - Spielzeugkiste finden Sie auf der Seite 68
Sponda junior e scaletta portagiochi a pagina 68



K536C-M7751
Drawers | Cajones inferiores
Tiroirs | Schubladen | Cassettoni
K536N-M7751
Trundle bed | Cama nido
Lit gigogne | Ausziehbett | Letto estraibile

SERO EVEN **CIELO**



K536C-M7752
Drawers | Cajones inferiores
Tiroirs | Schubladen | Cassettoni
K536N-M7752
Trundle bed | Cama nido
Lit gigogne | Ausziehbett | Letto estraibile

SERO EVEN **CORAL**



K536C-M7753
Drawers | Cajones inferiores
Tiroirs | Schubladen | Cassettoni
K536N-M7753
Trundle bed | Cama nido
Lit gigogne | Ausziehbett | Letto estraibile

SERO EVEN **ARENA**



K536C-M7778
Drawers | Cajones inferiores
Tiroirs | Schubladen | Cassettoni
K536N-M7778
Trundle bed | Cama nido
Lit gigogne | Ausziehbett | Letto estraibile

SERO EVEN **GREY**

3 STAGES | 3 ETAPAS | 3 ÉTAPES | 3 ETAPPEN | 3 FASI



K536C-M7781
Drawers | Cajones inferiores
Tiroirs | Schubladen | Cassettoni
K536N-M7781
Trundle bed | Cama nido
Lit gigogne | Ausziehbett | Letto estraibile

SERO EVEN **MARE**

BABY
0-3
years

106,5 x 206,4 x 102 cm

Convertible crib | Cuna convertible
Lit bébé évolutif | Verwandelbares Babybett
Lettino trasformabile

JUNIOR
+5
years

37,5 x 206,4 x 102 cm

Junior bed | Cama junior | Lit | Bett | Letto

With additional modules
Con módulos adicionales
Avec des modules supplémentaires
Mit Zusatzmodulen
Con moduli aggiuntivi

Convertible crib as bedroom
Cuna convertible desmontada como habitación
Lit bébé évolutif transformé en chambre
Verwandelbares Babybett als Jugendzimmer
Lettino trasformabile montato a cameretta

CONVERTIBLE CRIBS | CUNAS CONVERTIBLES
LITS BÉBÉ ÉVOLUTIFS | VERWANDELBARE BABYBETTEN | LETTINI TRASFORMABILI

SERO EVEN

70x140
90x200

MATTE
FINISH



K536C-M7700
Drawers | Cajones inferiores
Tiroirs | Schubladen | Cassettoni

K536N-M7700
Trundle bed | Cama nido
Lit gigogne | Ausziehbett | Letto estraibile

70 x 140 cm » 90 x 200 cm

105,5 x 206,4 x 102 cm
↑ → ↻

SERO EVEN WHITE



Bed guard & stairs - toybox see page 68 | Barandilla junior y escalera-juguetero en la página 68
Barrière junior et escalier - coffre à jouets voir page 68 | Gitter Junior und Treppe - Spielzeugkiste finden Sie auf der Seite 68
Sponda junior e scaletta portagiochi a pagina 68



K559C-M7700
Drawers | Cajones inferiores
Tiroirs | Schubladen | Cassettoni

K559N-M7700
Trundle bed | Cama nido
Lit gigogne | Ausziehbett | Letto estraibile

SERO JOY **WHITE**

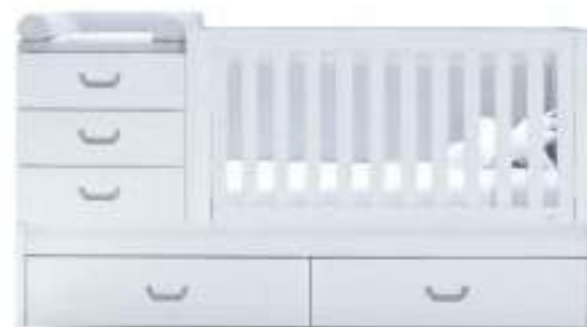

K559C-M7778
Drawers | Cajones inferiores
Tiroirs | Schubladen | Cassettoni

K559N-M7778
Trundle bed | Cama nido
Lit gigogne | Ausziehbett | Letto estraibile

SERO JOY **GREY**



K559C-M7779
Drawers | Cajones inferiores
Tiroirs | Schubladen | Cassettoni

K559N-M7779
Trundle bed | Cama nido
Lit gigogne | Ausziehbett | Letto estraibile

SERO JOY **ETNIK**



K559C-M7782
Drawers | Cajones inferiores
Tiroirs | Schubladen | Cassettoni

K559N-M7782
Trundle bed | Cama nido
Lit gigogne | Ausziehbett | Letto estraibile

SERO JOY **ROSE**

OPTIONS | OPCIONES | OPTIONS | OPTIONEN | OPZIONI



Convertible crib with drawers
Cuna convertible con cajones inferiores
Lit bébé évolutif avec tiroirs
Verwandelbares Babybett mit Schubladen
Lettino trasformabile con cassettoni



Convertible crib with trundle bed
Cuna convertible con cama nido
Lit bébé évolutif avec lit gigogne
Verwandelbares Babybett mit Ausziehbett
Lettino trasformabile con letto estraibile

3 STAGES | 3 ETAPAS | 3 ÉTAPES | 3 ETAPPEN | 3 FASI



BABY
0-3
years

Convertible crib | Cuna convertible
Lit bébé évolutif | Verwandelbares Babybett
Lettino trasformabile



KID
3-5
years

With additional modules
Con módulos adicionales
Avec des modules supplémentaires
Mit Zusatzmodulen
Con moduli aggiuntivi



JUNIOR
+5
years

Convertible crib as bedroom
Cuna convertible desmontada como habitación
Lit bébé évolutif transformé en chambre
Verwandelbares Babybett als Jugendzimmer
Lettino trasformabile montato a cameretta

37,5 x 206,4 x 102 cm
Junior bed | Cama junior | Lit | Bett | Letto

70x140
90x200

MATTE
FINISH



K559C-M7781
Drawers | Cajones inferiores
Tiroirs | Schubladen | Cassettoni

K559N-M7781
Trundle bed | Cama nido
Lit gigogne | Ausziehbett | Letto estraibile

105,5 x 206,4 x 102 cm
① ② ③

70 x 140 cm » 90 x 200 cm

SERO JOY MARE



Bed guard & stairs - toybox see page 68 | Barandilla junior y escalera-juguetero en la página 68
Barrière junior et escalier - coffre à jouets voir page 68 | Gitter Junior und Treppe - Spielzeugkiste finden Sie auf der Seite 68
Sponda junior e scaletta portagiochi a pagina 68



K551C-M7753
Drawers | Cajones inferiores
Tiroirs | Schubladen | Cassettoni
K551N-M7753
Trundle bed | Cama nido
Lit gigogne | Ausziehbett | Letto estraibile

SERO KUBO **ARENA**



K551C-M7755
Drawers | Cajones inferiores
Tiroirs | Schubladen | Cassettoni
K551N-M7755
Trundle bed | Cama nido
Lit gigogne | Ausziehbett | Letto estraibile

SERO KUBO **MINT**



K551C-M7778
Drawers | Cajones inferiores
Tiroirs | Schubladen | Cassettoni
K551N-M7778
Trundle bed | Cama nido
Lit gigogne | Ausziehbett | Letto estraibile

SERO KUBO **GREY**



K551C-M7781
Drawers | Cajones inferiores
Tiroirs | Schubladen | Cassettoni
K551N-M7781
Trundle bed | Cama nido
Lit gigogne | Ausziehbett | Letto estraibile

SERO KUBO **MARE**



K551C-M7782
Drawers | Cajones inferiores
Tiroirs | Schubladen | Cassettoni
K551N-M7782
Trundle bed | Cama nido
Lit gigogne | Ausziehbett | Letto estraibile

SERO KUBO **ROSE**

3 STAGES | 3 ETAPAS | 3 ÉTAPES | 3 ETAPPEN | 3 FASI



BABY
0-3
years

Convertible crib | Cuna convertible
Lit bébé évolutif | *Verwandelbares Babybett*
Lettino trasformabile



KID
3-5
years

With additional modules
Con módulos adicionales
Avec des modules supplémentaires
Mit Zusatzmodulen
Con moduli aggiuntivi



JUNIOR
+5
years

Convertible crib as bedroom
Cuna convertible desmontada como habitación
Lit bébé évolutif transformé en chambre
Verwandelbares Babybett als Jugendzimmer
Lettino trasformabile montato a cameretta

37,5 x 206,4 x 102 cm

CONVERTIBLE CRIBS | CUNAS CONVERTIBLES
LITS BÉBÉ ÉVOLUTIFS | VERWANDELBARE BABYBETTEN | LETTINI TRASFORMABILI

SERO KUBO

70x140
90x200

MATTE
FINISH



K551C-M7700
Drawers | Cajones inferiores
Tiroirs | Schubladen | Casseltoni

K551N-M7700
Trundle bed | Cama nido
Lit gigogne | Ausziehbett | Letto estraibile

105,5 x 206,4 x 102 cm



70 x 140 cm » 90 x 200 cm

SERO KUBO WHITE

BABY
0-3
years



105,5 x 206,4 x 102 cm

Convertible crib | Cuna convertible
Lit bébé évolutif | *Verwandelbares Babybett*
Letino trasformabile

KID
3-5
years



105,5 x 206,4 x 102 cm

Convertible crib as cot with additional modules | Cuna convertible montada con módulos adicionales
Lit bébé évolutif avec des modules supplémentaires | *Verwandelbares Babybett als Kinderbett mit Zusatzmodulen*
Letino trasformabile montato con moduli aggiuntivi

JUNIOR
+5
years



37,5 x 206,4 x 102 cm

Junior bed | Cama junior
Lit | Bett | Letto

Convertible crib as junior bedroom | Cuna convertible desmontada como habitación infantil | Lit bébé évolutif transformé en chambre junior
Verwandelbares Babybett als Jugendzimmer | Letino trasformabile montato a cameretta

70x140
90x200

MATTE
FINISH



K537C-M9477
Drawers | Cajones inferiores
Tiroirs | Schubladen | Cassettoni

K537N-M9477
Trundle bed | Cama nido
Lit gigogne | Ausziehbett | Letto estraibile

105,5 x 206,4 x 102 cm
↑ → ↻

70 x 140 cm » 90 x 200 cm



Drawers | Cajones inferiores
Tiroirs | Schubladen | Cassettoni

K417CR-M7700

Dropside on the right | Barandilla montada a la derecha
Barrière à droite | Gitter auf der rechten Seite
Sponda montata a destra

Dropside on the left | Barandilla montada a la izquierda
Barrière à gauche | Gitter auf der linken Seite
Sponda montata a sinistra

K417CL-M7700

Trundle bed | Cama nido
Lit gigogne | Ausziehbett | Letto estraibile

K417NR-M7700

K417NL-M7700

KURVE WHITE



Drawers | Cajones inferiores
Tiroirs | Schubladen | Cassettoni

K417CR-M7778

Dropside on the right | Barandilla montada a la derecha
Barrière à droite | Gitter auf der rechten Seite
Sponda montata a destra

Dropside on the left | Barandilla montada a la izquierda
Barrière à gauche | Gitter auf der linken Seite
Sponda montata a sinistra

K417CL-M7778

Trundle bed | Cama nido
Lit gigogne | Ausziehbett | Letto estraibile

K417NR-M7778

K417NL-M7778

KURVE GREY



Drawers | Cajones inferiores
Tiroirs | Schubladen | Cassettoni

K417CR-M7791

Dropside on the right | Barandilla montada a la derecha
Barrière à droite | Gitter auf der rechten Seite
Sponda montata a destra

Dropside on the left | Barandilla montada a la izquierda
Barrière à gauche | Gitter auf der linken Seite
Sponda montata a sinistra

K417CL-M7791

Trundle bed | Cama nido
Lit gigogne | Ausziehbett | Letto estraibile

K417NR-M7791

K417NL-M7791

KURVE NATURE



Drawers | Cajones inferiores
Tiroirs | Schubladen | Cassettoni

K417CR-M7792

Dropside on the right | Barandilla montada a la derecha
Barrière à droite | Gitter auf der rechten Seite
Sponda montata a destra

Dropside on the left | Barandilla montada a la izquierda
Barrière à gauche | Gitter auf der linken Seite
Sponda montata a sinistra

K417CL-M7792

Trundle bed | Cama nido
Lit gigogne | Ausziehbett | Letto estraibile

K417NR-M7792

K417NL-M7792

KURVE COCO

OPTIONS | OPCIONES

OPTIONS | OPTIONEN | OPZIONI



Dropside on the right
Barandilla montada a la derecha
Barrière à droite
Gitter auf der rechten Seite
Sponda montata a destra



Dropside on the left
Barandilla montada a la izquierda
Barrière à gauche
Gitter auf der linken Seite
Sponda montata a sinistra

3 STAGES | 3 ETAPAS | 3 ÉTAPES | 3 ETAPPEN | 3 FASI



BABY
0-3
years

Convertible crib | Cuna convertible
Lit bébé évolutif | Verwandelbares Babybett
Letтино trasformabile



KID
3-5
years

With additional modules
Con módulos adicionales
Avec des modules supplémentaires
Mit Zusatzmodulen
Con moduli aggiuntivi



JUNIOR
+5
years

Convertible crib as bedroom
Cuna convertible desmontada como habitación
Lit bébé évolutif transformé en chambre
Verwandelbares Babybett als Jugendzimmer
Letтино trasformabile montato a cameretta

101,7 x 214,1 x 101,8 cm

Junior bed | Cama junior | Lit | Bett | Letto

CONVERTIBLE CRIBS | CUNAS CONVERTIBLES
LITS BÉBÉ ÉVOLUTIFS | VERWANDELBARE BABYBETTEN | LETTINI TRASFORMABILI

PREMIUM KURVE

70x140
90x200

MATTE
FINISH

PREMIUM

103,4 x 214,1 x 101,8 cm
↑ → ↻

K417CR-M7700
Drawers | Cajones inferiores
Tiroirs | Schubladen | Cassettoni
70 x 140 cm » 90 x 200 cm



CONVERTIBLE CRIBS | CUNAS CONVERTIBLES

LITS BÉBÉ ÉVOLUTIFS | VERWANDELBARE BABYBETTEN | LETTINI TRASFORMABILI

Bed guard see page 68 | Barandilla junior en la página 68
Barrière junior voir page 68 | Gitter Junior finden Sie auf der Seite 68
Sponda junior a pagina 68



JUNIOR
+3
years



Junior bed | Cama junior
Lit | Bett | Letto

110 x 205,6 x 120 cm

Convertible crib as junior bedroom | Cuna convertible desmontada como habitación infantil | Lit bébé évolutif transformé en chambre junior | Verwandelbares Babybett als Jugendzimmer | Lettino trasformabile montato a cameretta



Upper view of the cribs
Vista superior
Vue supérieure des lits bébé
Ansicht von oben
Vista dall'alto

OPTIONS | OPCIONES | OPTIONS | OPTIONEN | OPZIONI



The divider located between the cribs is open, so the babies can see each other and interact | El separador de las dos cunas es abierto, por lo que permite la comunicación e interacción de los bebés | Le séparateur qui se trouve entre les lits bébé est ouvert, afin que les bébés puissent interagir | Die Trennwand zwischen der Babybetten ist offen, damit die Babys interagieren können | Pannello separatore dei due lettini a stecche (aperto) per facilitare l'interazione dei due bimbi

Optional drawers | Cajones adicionales
Tiroirs additionnels | Zusätzliche Schubladen
Cassetti aggiuntivi

DUPLO

WHITE

BABY
0-3
years

MATTE
FINISH

60x120
90x120



T1220-M7700

101 x 249,4 x 65,4 cm
↑ → ↻

Twin convertible crib 60x120 and 90x200 cm. 1 double desk | Cuna convertibile gemelar 60x120 y 90x200 cm. 1 escritorio doble | Lit bébé évolutif pour jumeaux 60x120 et 90x200 cm. 1 bureau double
Verwandlbares Babybett für Zwillinge 60x120 und 90x200 cm. 1 Doppelschreibtisch | Lettino trasformabile gemellare 60x120 e 90x200 cm. 1 doppia scrivania

ACCESSORIES | ACCESORIOS | ACCESSOIRES | ZUBEHÖR | ACCESSORI

JB400 Bed guard | Barandilla junior | Barrière junior | Gitter Junior | Sponda junior

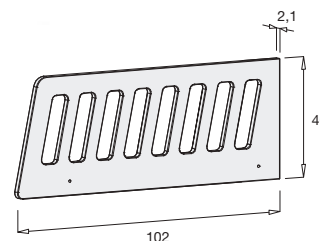

Reference Referencia Référence Referenz Riferimento	Colour Color Couleur Farbe Colore
JB400-G23	Gloss white Blanco brillo Blanc brillant Weiss glanz Bianco lucido
JB400-M77	Matte white Blanco mate Blanc mat Weiss matt Bianco opaco

Compatible with Konvers ranges
Compatible with los Konvers
Compatible avec les gammes Konver
Kompatibel für die Konvers
Compatibile con Konvers

PREMIUM KURVE

JB502 Bed guard | Barandilla junior | Barrière junior | Gitter Junior | Sponda junior

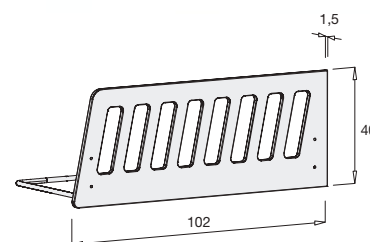

Reference Referencia Référence Referenz Riferimento	Colour Color Couleur Farbe Colore
JB502-G23	Gloss white Blanco brillo Blanc brillant Weiss glanz Bianco lucido
JB502-M77	Matte white Blanco mate Blanc mat Weiss matt Bianco opaco

Compatible with all Alondra 70x140 convertible cribs
Compatible con todos los Konvers de 70x140 de Alondra
Compatible avec tous les lits évolutifs Alondra en 70x140
Kompatibel für alle Alondra Konvers mit den Massen 70x140
Compatibile con tutti i Konvers Alondra di 70x140

JU400 Stairs - toybox | Escalera-juguetero | Escalier - coffre à jouets | Treppe - Spielzeugkiste | Scaletta portagiochi

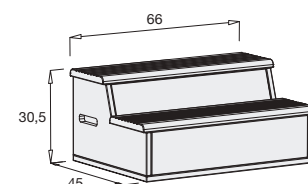

Reference Referencia Référence Referenz Riferimento	Colour Color Couleur Farbe Colore
JU400-G23	Gloss white Blanco brillo Blanc brillant Weiss glanz Bianco lucido
JU400-M77	Matte white Blanco mate Blanc mat Weiss matt Bianco opaco

Compatible with all Alondra 70x140 convertible cribs
Compatible con todos los Konvers de 70x140 de Alondra
Compatible avec tous les lits évolutifs Alondra en 70x140
Kompatibel für alle Alondra Konvers mit den Massen 70x140
Compatibile con tutti i Konvers Alondra di 70x140

ACCESSORIES

J370G / J370M Additional drawers | Cajones inferiores | Tiroirs additionnels | Zusätzliche Schubladen | Cassetti inferiori



Compatible with the Konver range | Compatible con los Konvers
Compatible avec la gamme Konver | Kompatibel für den Konvers
Compatible con Konvers

JUST · DUPLO

J370G-M7700

Large drawer | Cajón grande | Grand tiroir
Große Schublade | Cassetto grande

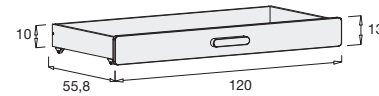

J370M-M7700

Small drawer | Cajón pequeño | Petit tiroir
Kleine Schublade | Cassetto piccolo

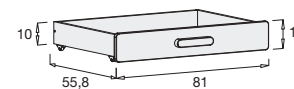

Optional drawers ref. J370G and J370M can only be used under the junior bed (not compatible with the cot during the BABY stage).

Los cajones opcionales J370G y J370M únicamente se pueden poner bajo la cama junior, nunca bajo la cuna en la etapa BABY.

Les tiroirs supplémentaires réf. J370G et J370M ne peuvent être utilisés qu'en dessous du lit junior (pas compatibles avec le lit évolutif pendant l'étape BABY).

Die optionalen Schubladen Ref. J370G und J370M können nur mit dem Jugendbett genutzt werden, niemals mit dem Babybett.

I cassetti aggiuntivi J370G e J370M possono essere collocati solo sotto il letto da 90x200 derivante dalla trasformazione del lettino. NON compatibile con il Konver JUST montato in fase BABY.

V656 Changer support | Soporte vestidor | Support commode à langer Wickelaufsatz | Supporto fasciatoio cassettiere

STAGE 1 | ETAPA 1 | ÉTAPE 1 ETAPPE 1 | FASE 1



STAGE 2 | ETAPA 2 | ÉTAPE 2 ETAPPE 2 | FASE 2



Sideways | Posición lateral Position latérale | Seitlich Vista laterale

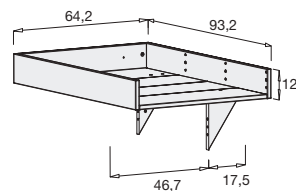

Frontal | Posición frontal Position frontale | Frontal Vista frontale

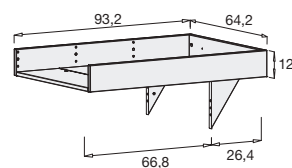

Compatible with the chest ranges | Compatible con las cómodas
Compatible avec les commodes | Kompatibel für die Kommoden
Compatible con cassettiere

EVEN · PREMIUM · SCANDI

Shelf Estantería Étagère murale Regal Mensola

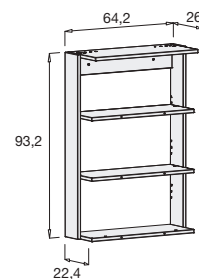

Reference Referencia Référence Referenz Riferimento	Colour Color Couleur Farbe Colore
V656-G2300	Gloss white Blanco brillo Blanc brillant Weiss glanz Bianco lucido
V656-M7700	Matte white Blanco mate Blanc mat Weiss matt Bianco opaco

V657 Changer support | Soporte vestidor | Support commode à langer Wickelaufsatz | Supporto fasciatoio cassettiere

STAGE 1 | ETAPA 1 | ÉTAPE 1 ETAPPE 1 | FASE 1



STAGE 2 | ETAPA 2 | ÉTAPE 2 ETAPPE 2 | FASE 2



Sideways | Posición lateral Position latérale | Seitlich Vista laterale

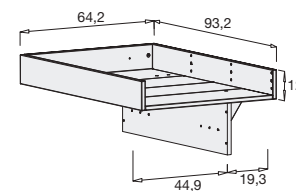

Frontal | Posición frontal Position frontale | Frontal Vista frontale

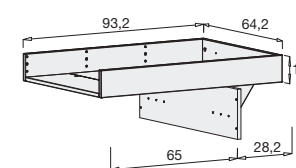

Compatible with the chest ranges | Compatible con las cómodas
Compatible avec les commodes | Kompatibel für die Kommoden
Compatible con cassettiere

BUBBLE · JOY

Shelf Estantería Étagère murale Regal Mensola

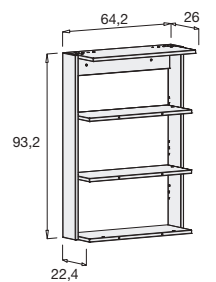

Reference Referencia Référence Referenz Riferimento	Colour Color Couleur Farbe Colore
V657-G2300	Gloss white Blanco brillo Blanc brillant Weiss glanz Bianco lucido
V657-M7700	Matte white Blanco mate Blanc mat Weiss matt Bianco opaco

BABY FURNITURE

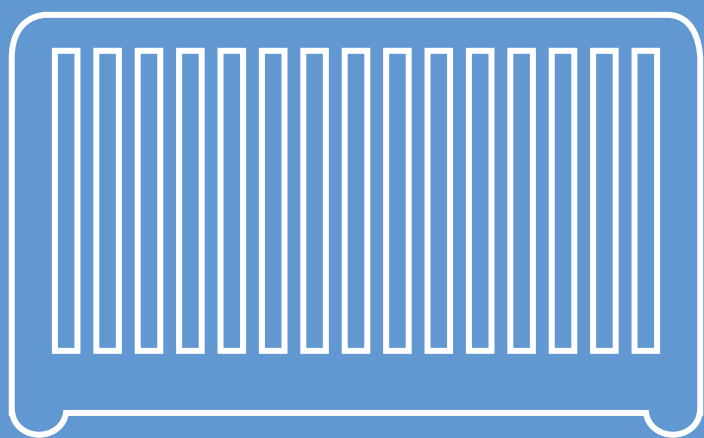

BABY FURNITURE | MOBILIARIO INFANTIL | MOBILIER BÉBÉ
BABYMÖBEL | MOBILI PER BAMBINI

Wardrobes | Armarios | Armoires | Schränke | Armadi



A387R-M7795

↑ 197,2 cm → 108,2 cm ↻ 61,8 cm



Close-up of the feet
Detalle de la pata del mueble
Vue rapprochée du pied
Detailansicht der Möbelfüsse
Particolare del piedino del mobile

Chests | Cómодas | Commodes | Kommoden | Cassettiere



V656-M7700

Optional changer support
Soporte vestidor opcional
Plan à langer supplémentaire
Zusätzlicher Wickelaufsatz
Supporto fasciatoio supplementare



D287R-M7795

↑ 90 cm → 108,2 cm ↻ 51,5 cm

60 x 120 cm

Co-sleeping cot | Cuna de colecho | Lit bébé cododo | Beistellbett | Lettino fianco letto

2 stages by default | 2 etapas de serie | 2 étapes d'office | 2 Etappen standardmäßig | 2 fasi di serie



Cot 60x120 | Cuna 60x120 | Lit bébé 60x120
Babybett 60x120 | Lettino 60x120

C187R-M7795

↑ 90,3 cm → 126,1 cm ↻ 66,8 cm



Cot 60x120 | Cuna 60x120 | Lit bébé 60x120
Babybett 60x120 | Lettino 60x120



Desk | Escritorio infantil | Bureau
Schreibtisch | Scrivania



4 stages with additional kits or accessories | 4 etapas con packs o accesorios adicionales

4 étapes avec des kits ou accessoires supplémentaires | 4 Etappen mit zusätzlichen Kits oder Zubehör | 4 fasi con packs o accessori opzionali



Co-sleeping cot | Cuna de colecho | Lit bébé cododo
Beistellbett | Lettino fianco letto



Toddler bed | Camita infantil | Lit cadet
Juniorbett | Lettino sponda junior

* +info pages 32-33

MATTE
FINISH

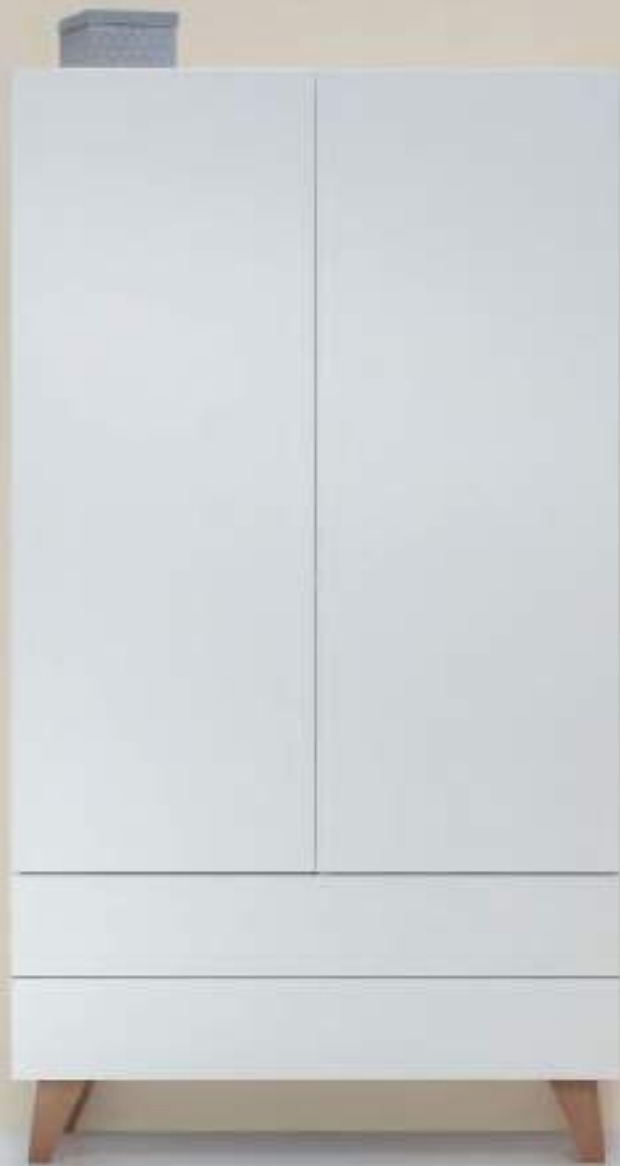

A387R-M7795



C187R-M7795
60 x 120 cm
NEXOR (pages 32-33)



D287R-M7795

Wardrobes | Armarios | Armoires | Schränke | Armadi



A387-M7700

↑ 197,2 cm → 108,2 cm ↻ 61,8 cm



Close-up of the feet
Detalle de la pata del mueble
Vue rapprochée du pied
Detailansicht der Möbelfüsse
Particolare del piedino del mobile

Chests | Cómодas | Commodes | Kommoden | Cassettiere



D287-M7700

↑ 90 cm → 108,2 cm ↻ 51,5 cm



V656-M7700

Optional changer support
Soporte vestidor opcional
Plan à langer supplémentaire
Zusätzlicher Wickelaufsatz
Supporto fasciatoio supplementare

60 x 120 cm

Co-sleeping cot | Cuna de colecho | Lit bébé cododo | Beistellbett | Lettino fianco letto

2 stages by default | 2 etapas de serie | 2 étapes d'office | 2 Etappen standardmäßig | 2 fasi di serie



Cot 60x120 | Cuna 60x120 | Lit bébé 60x120
Babybett 60x120 | Lettino 60x120

C187-M7700

↑ 90,3 cm → 126,1 cm ↻ 66,8 cm



Cot 60x120 | Cuna 60x120 | Lit bébé 60x120
Babybett 60x120 | Lettino 60x120



Desk | Escritorio infantil | Bureau
Schreibtisch | Scrivania



4 stages with additional kits or accessories | 4 etapas con packs o accesorios adicionales

4 étapes avec des kits ou accessoires supplémentaires | 4 Etappen mit zusätzlichen Kits oder Zubehör | 4 fasi con packs o accessori opzionali



Co-sleeping cot | Cuna de colecho | Lit bébé cododo
Beistellbett | Lettino fianco letto



Toddler bed | Camita infantil | Lit cadet
Juniorbett | Lettino sponda junior

* +info pages 32-33

SCANDI

WHITE

MATTE
FINISH



A387-M7700



C187-M7700
60 x 120 cm
NEXO (pages 32-33)



D287-M7700

Wardrobes | Armarios | Armoires | Schränke | Armadi

Chests | Cómodas | Commodes | Kommoden | Cassettiere



V657-M7700

Optional changer support
Soporte vestidor opcional
Plan à langer supplémentaire
Zusätzlicher Wickelaufsatz
Supporto fasciatoio supplementare

A359G

↑ 204,8 cm → 120 cm ↻ 61,6 cm

- A359G-M7700
- A359G-M7778
- A359G-M7779
- A359G-M7781
- A359G-M7782

A359

↑ 204,8 cm → 80 cm ↻ 61,6 cm

- A359-M7700
- A359-M7778
- A359-M7779
- A359-M7781
- A359-M7782

D259G

↑ 84,8 cm → 120 cm ↻ 61,6 cm

- D259G-M7700
- D259G-M7778
- D259G-M7779
- D259G-M7781
- D259G-M7782

D259C

↑ 84,8 cm → 80 cm ↻ 61,6 cm

- D259C-M7700
- D259C-M7778
- D259C-M7779
- D259C-M7781
- D259C-M7782

D259

↑ 84,8 cm → 80 cm ↻ 61,6 cm

- D259-M7700
- D259-M7778
- D259-M7779
- D259-M7781
- D259-M7782

60 x 120 cm
Cots | Cunas | Lits bébé | Babybetten | Lettini

70 x 140 cm
Cots | Cunas | Lits bébé | Babybetten | Lettini

Bath changers | Bañeras
Baignoires | Waschtische | Bagnetti



Cot 60x120 | Cuna 60x120 | Lit bébé 60x120
Babybett 60x120 | Lettino 60x120

Cot 70x140 | Cuna 70x140 | Lit bébé 70x140
Babybett 70x140 | Lettino 70x140

Toddler bed | Cama infantil | Lit cadet
Kinderbett | Lettino sponda junior

C150

↑ 80 cm → 132 cm ↻ 64 cm

- C150-M7700
- C150-M7778
- C150-M7779
- C150-M7781
- C150-M7782

C160

↑ 79,5 cm → 150 cm ↻ 74,1 cm

- C160-M7700
- C160-M7778
- C160-M7779
- C160-M7781
- C160-M7782

B759

↑ 93 cm → 79 cm ↻ 49 cm

- B759-M7700
- B759-M7778
- B759-M7779
- B759-M7781
- B759-M7782

60 x 120 cm
Co-sleeping cot | Cuna de colecho | Lit bébé cododo | Beistellbett | Lettino fianco letto

70 x 140 cm
Co-sleeping cot | Cuna de colecho | Lit bébé cododo | Beistellbett
Lettino fianco letto



C181

↑ 91 cm → 126 cm ↻ 73 cm



* +info pages 22-23

5 stages with additional kits or accessories
5 etapas con packs o accesorios adicionales
5 étapes avec des kits ou accessoires supplémentaires
5 Etappen mit zusätzlichen Kits oder Zubehör
5 fasi con packs o accessori opzionali



C187-M7700

↑ 90,3 cm → 126,1 cm ↻ 66,8 cm

* +info pages 32-33

4 stages with additional kits or accessories
4 etapas con packs o accesorios adicionales
4 étapes avec des kits ou accessoires supplémentaires
4 Etappen mit zusätzlichen Kits oder Zubehör
4 fasi con packs o accessori opzionali



C191

↑ 90,5 cm → 146,1 cm ↻ 82,5 cm



* +info pages 24-25

6 stages with additional kits or accessories
6 etapas con packs o accesorios adicionales
6 étapes avec des kits ou accessoires supplémentaires
6 Etappen mit zusätzlichen Kits oder Zubehör
6 fasi con packs o accessori opzionali



D259G-M7779

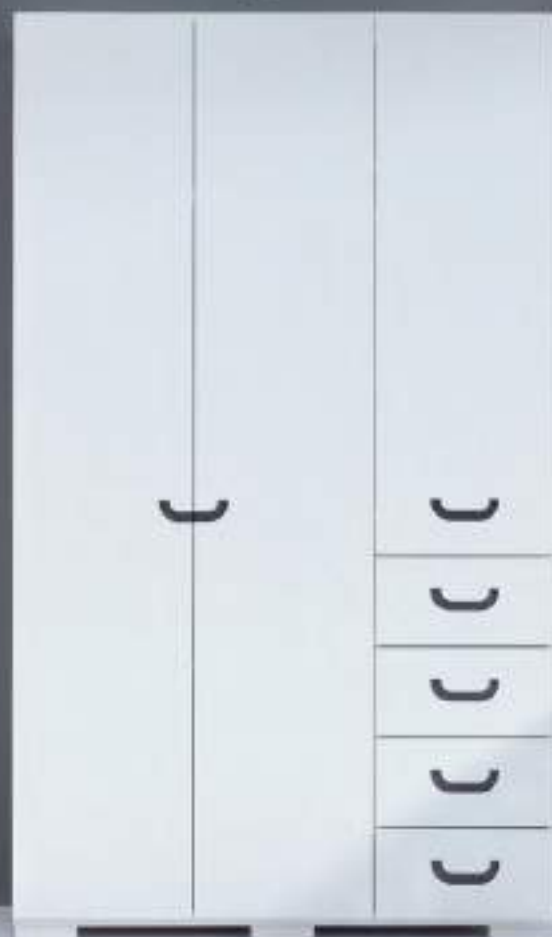

A359G-M7779



C150-M7779
60x120 cm



JOY WHITE



JOY GREY

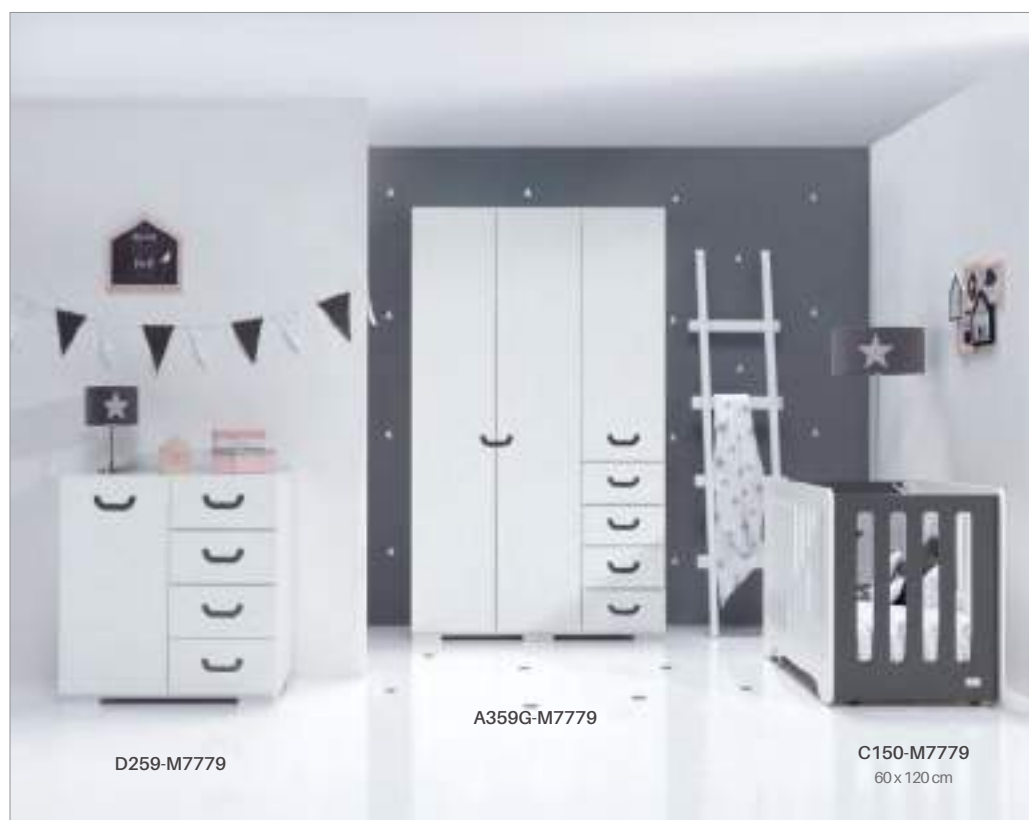

JOY ETNIK



JOY ROSE

MATTE
FINISH



A359G-M7781



C150-M7781
60x120 cm



D259-M7781

Wardrobes | Armarios | Armoires | Schränke | Armadi



Close-up of the feet
 Detalle de la pata del mueble
 Vue rapprochée du pied
 Detailansicht der Möbelfüsse
 Particolare del piedino del mobile

A336

↑ 202,2 cm → 108,2 cm ↻ 61,8 cm

- A336-M7700
- A336-M7751
- A336-M7752
- A336-M7753
- A336-M7778
- A336-M7781

Chests | Cómicas | Commodes | Kommoden | Cassettiere



V656-M7700

Optional changer support
 Soporte vestidor opcional
 Plan à langer supplémentaire
 Zusätzlicher Wickelaufsatz
 Supporto fasciatoio supplementare



D236

↑ 95 cm → 108,2 cm ↻ 51,5 cm

- D236-M7700
- D236-M7751
- D236-M7752
- D236-M7753
- D236-M7778
- D236-M7781

60 x 120 cm

Cots | Cunas | Lits bébé | Babybetten | Lettini



Cot 60x120 | Cuna 60x120 | Lit bébé 60x120
 Babybett 60x120 | Lettino 60x120

C150

↑ 80 cm → 132 cm ↻ 64 cm

- C150-M7700
- C150-M7751
- C150-M7752
- C150-M7753
- C150-M7778
- C150-M7781

70 x 140 cm

Cots | Cunas | Lits bébé | Babybetten | Lettini



Cot 70x140 | Cuna 70x140 | Lit bébé 70x140
 Babybett 70x140 | Lettino 70x140

C160

↑ 79,5 cm → 150 cm ↻ 74,1 cm

- C160-M7700
- C160-M7751
- C160-M7752
- C160-M7753
- C160-M7778
- C160-M7781



Toddler bed | Cama infantil | Lit cadet
 Kinderbett | Lettino sponda junior

60 x 120 cm

Co-sleeping cot | Cuna de colecho | Lit bébé cododo | Beistellbett | Lettino fianco letto



C181

↑ 91 cm → 126 cm ↻ 73 cm



* +info pages 22-23
5 stages with additional kits or accessories
 5 etapas con packs o accesorios adicionales
 5 étapes avec des kits ou accessoires supplémentaires
 5 Etappen mit zusätzlichen Kits oder Zubehör
 5 fasi con packs o accessori opzionali



C187-M7700

↑ 90,3 cm → 126,1 cm ↻ 66,8 cm

* +info pages 32-33
4 stages with additional kits or accessories
 4 etapas con packs o accesorios adicionales
 4 étapes avec des kits ou accessoires supplémentaires
 4 Etappen mit zusätzlichen Kits oder Zubehör
 4 fasi con packs o accessori opzionali

70 x 140 cm

Co-sleeping cot | Cuna de colecho | Lit bébé cododo | Beistellbett | Lettino fianco letto



C191

↑ 90,5 cm → 146,1 cm ↻ 82,5 cm



* +info pages 24-25
6 stages with additional kits or accessories
 6 etapas con packs o accesorios adicionales
 6 étapes avec des kits ou accessoires supplémentaires
 6 Etappen mit zusätzlichen Kits oder Zubehör
 6 fasi con packs o accessori opzionali

MATTE
FINISH



D236-M7778

A336-M7778

C150-M7778
60x120 cm

EVEN GREY



EVEN **WHITE**



EVEN **CIELO**



EVEN **ARENA**



EVEN **MARE**



D236-M7752



C150-M7752
60x120cm



A336-M7752

EVEN CORAL

Wardrobes | Armarios | Armoires | Schränke | Armadi



A354G

↑ 204,8 cm → 120 cm ↻ 61,6 cm

- A354G-M7700
- A354G-M7751
- A354G-M7752
- A354G-M7753
- A354G-M7755
- A354G-M7778

A354

↑ 204,8 cm → 80 cm ↻ 61,6 cm

- A354-M7700
- A354-M7751
- A354-M7752
- A354-M7753
- A354-M7755
- A354-M7778

Chests | Cómodas | Commodes | Kommoden | Cassettiere



D254G

↑ 84,8 cm → 120 cm ↻ 61,6 cm

- D254G-M7700
- D254G-M7751
- D254G-M7752
- D254G-M7753
- D254G-M7755
- D254G-M7778

D254C

↑ 84,8 cm → 80 cm ↻ 61,6 cm

- D254C-M7700
- D254C-M7751
- D254C-M7752
- D254C-M7753
- D254C-M7755
- D254C-M7778

D254

↑ 84,8 cm → 80 cm ↻ 61,6 cm

- D254-M7700
- D254-M7751
- D254-M7752
- D254-M7753
- D254-M7755
- D254-M7778



V657-M7700

Optional changer support
 Soporte vestidor opcional
 Plan à langer supplémentaire
 Zusätzlicher Wickelaufsatz
 Supporto fasciatoio supplementare

60 x 120 cm
Cots | Cunas | Lits bébé | Babybetten | Lettini



Cot 60x120 | Cuna 60x120 | Lit bébé 60x120
Babybett 60x120 | Lettino 60x120

C150

↑ 80 cm → 132 cm ↻ 64 cm

- C150-M7700
- C150-M7751
- C150-M7752
- C150-M7753
- C150-M7755
- C150-M7778

70 x 140 cm
Cots | Cunas | Lits bébé | Babybetten | Lettini



Cot 70x140 | Cuna 70x140 | Lit bébé 70x140
Babybett 70x140 | Lettino 70x140

C160

↑ 79,5 cm → 150 cm ↻ 74,1 cm

- C160-M7700
- C160-M7751
- C160-M7752
- C160-M7753
- C160-M7755
- C160-M7778



Toddler bed | Cama infantil | Lit cadet
Kinderbett | Lettino sponda junior

Bath changers | Bañeras
 Baignoires | *Waschtische* | Bagnetti



B754

↑ 93 cm → 79 cm ↻ 49 cm

- B754-M7700
- B754-M7751
- B754-M7752
- B754-M7753
- B754-M7755
- B754-M7778

60 x 120 cm
Co-sleeping cot | Cuna de colecho | Lit bébé cododo | Beistellbett | Lettino fianco letto



C181

↑ 91 cm → 126 cm ↻ 73 cm



* +info pages 22-23
5 stages with additional kits or accessories
 5 etapas con packs o accesorios adicionales
 5 étapes avec des kits ou accessoires supplémentaires
 5 Etappen mit zusätzlichen Kits oder Zubehör
 5 fasi con packs o accessori opzionali



C187-M7700

↑ 90,3 cm → 126,1 cm ↻ 66,8 cm



* +info pages 32-33
4 stages with additional kits or accessories
 4 etapas con packs o accesorios adicionales
 4 étapes avec des kits ou accessoires supplémentaires
 4 Etappen mit zusätzlichen Kits oder Zubehör
 4 fasi con packs o accessori opzionali

70 x 140 cm
Co-sleeping cot | Cuna de colecho | Lit bébé cododo | Beistellbett | Lettino fianco letto



C191

↑ 90,5 cm → 146,1 cm ↻ 82,5 cm



* +info pages 24-25
6 stages with additional kits or accessories
 6 etapas con packs o accesorios adicionales
 6 étapes avec des kits ou accessoires supplémentaires
 6 Etappen mit zusätzlichen Kits oder Zubehör
 6 fasi con packs o accessori opzionali

BUBBLE

MATTE
FINISH



D254G-M7778

A354G-M7778

C150-M7778
60 x 120 cm

BUBBLE GREY



BUBBLE CIELO



BUBBLE CORAL



BUBBLE ARENA



BUBBLE MINT

BUBBLE

MATTE
FINISH



D254G-M7700

C150-M7700
60x120 cm

A354G-M7700

BUBBLE WHITE

PREMIUM KURVE

ESSENCE WHITE

MATTE
FINISH

PREMIUM



A317PL-M7700



D217PL-M7700



C137PL-M7700
70x140 cm



↑ 201,5 cm → 109,8 cm ↻ 60 cm

A317PL

▫ A317PL-M7700
▫ A317PL-M7778



↑ 90 cm → 109,9 cm ↻ 49,5 cm

D217PL

▫ D217PL-M7700
▫ D217PL-M7778



Cot 70x140 | Cuna 70x140 | Lit bébé 70x140
Babybett 70x140 | Lettino 70x140

↑ 87,1 cm → 146 cm ↻ 80 cm

C137PL

▫ C137PL-M7700
▫ C137PL-M7778



Toddler bed | Cama infantil | Lit cadet
Kinderbett | Letto

↑ 76,6 cm → 146 cm ↻ 80 cm



Desk | Escritorio | Bureau
Schreibtisch | Scrivania

↑ 74,6 cm → 146 cm ↻ 80 cm

PREMIUM KURVE

ESSENCE NATURE

PREMIUM

MATTE
FINISH



C137P-M7791
70x140 cm



A317P-M7791



D217P-M7791



↑ 201,5 cm → 109,8 cm ↻ 60 cm
A317P-M7791



↑ 90 cm → 109,9 cm ↻ 49,5 cm
D217P-M7791



↑ 87,1 cm → 146 cm ↻ 80 cm
C137P-M7791



Toddler bed | Cama infantil | Lit cadet
Kinderbett | Letto

↑ 76,6 cm → 146 cm ↻ 80 cm



Desk | Escritorio | Bureau
Schreibtisch | Scrivania

↑ 74,6 cm → 146 cm ↻ 80 cm

PREMIUM KURVE

ESSENCE COCO

MATTE
FINISH

PREMIUM



C137P-M7792
70x140cm



A317P-M7792



D217P-M7792



↑ 201,5 cm → 109,8 cm ↻ 60 cm
A317P-M7792



↑ 90 cm → 109,9 cm ↻ 49,5 cm
D217P-M7792



↑ 87,1 cm → 146 cm ↻ 80 cm
C137P-M7792



Toddler bed | Cama infantil | Lit cadet
Kinderbett | Letto

↑ 76,6 cm → 146 cm ↻ 80 cm



Desk | Escritorio | Bureau
Schreibtisch | Scrivania

↑ 74,6 cm → 146 cm ↻ 80 cm

PREMIUM KURVE

WHITE

PREMIUM

MATTE
FINISH



A317-M7700

D217-M7700

C137-M7700
70 x 140 cm



↑ 199,5 cm → 109,8 cm ↻ 60 cm

A317-M7700



↑ 84 cm → 109,9 cm ↻ 49,5 cm

D217-M7700



↑ 86,4 cm → 146 cm ↻ 80 cm

C137-M7700



↑ 75,9 cm → 146 cm ↻ 80 cm

Toddler bed | Cama infantil | Lit cadet
Kinderbett | Letto



↑ 74,6 cm → 146 cm ↻ 80 cm

Desk | Escritorio | Bureau
Schreibtisch | Scrivania

PREMIUM KURVE

GREY

MATTE
FINISH

PREMIUM



A317-M7778



D217-M7778



C137-M7778
70x140 cm



↑ 199,5 cm → 109,8 cm ↻ 60 cm
A317-M7778



↑ 84 cm → 109,9 cm ↻ 49,5 cm
D217-M7778



↑ 86,4 cm → 146 cm ↻ 80 cm
C137-M7778



↑ 75,9 cm → 146 cm ↻ 80 cm



↑ 74,6 cm → 146 cm ↻ 80 cm

Cot 70x140 | Cuna 70x140 | Lit bébé 70x140
Babybett 70x140 | Lettino 70x140

Toddler bed | Cama infantil | Lit cadet
Kinderbett | Letto

Desk | Escritorio | Bureau
Schreibtisch | Scrivania

COTS & BATH CHANGERS

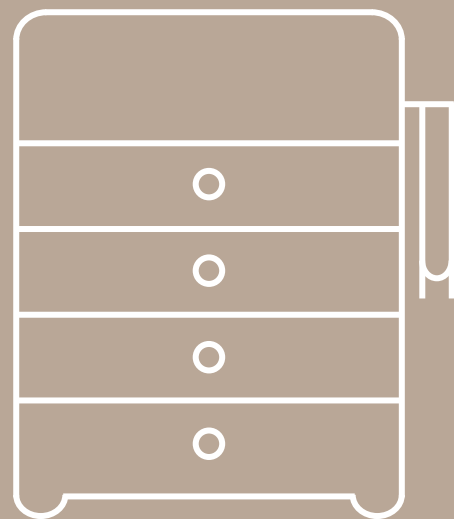

COTS & BATH CHANGERS | CUNAS Y BAÑERAS | LITS BÉBÉ ET BAIGNOIRES
BABYBETTEN UND WASCHTISCHE | LETTINI E BAGNETTI

KUBO



WHITE

MATTE
FINISH



C187R-M7795 + WJB180-M77
60 x 120 cm
NEXOR (pages 32-33)



633-114

B751-M7700



B751

↑ → ↻
93 x 79 x 49 cm

C187R*

↑ → ↻
90,3 x 125,3 x 66,8 cm

* +info pages 32-33
4 stages with additional kits or accessories
4 etapas con packs o accesorios adicionales
4 étapes avec des kits ou accessoires supplémentaires
4 Etappen mit zusätzlichen Kits und Zubehör
4 fasi con packs o accessori opzionali

MATTE
FINISH



C187-M7700 + WJB180-M77
60 x 120 cm
NEXO (pages 32-33)

B737
↑ → ↻
93 x 79 x 49 cm

C187 *
↑ → ↻
90,3 x 125,3 x 66,8 cm



* +info pages 32-33
4 stages with additional kits or accessories
4 etapas con packs o accesorios adicionales
4 étapes avec des kits ou accessoires supplémentaires
4 Etappen mit zusätzlichen Kits und Zubehör
4 fasi con packs o accessori opzionali



633-194



B737-M9477



JOY WHITE



JOY GREY



JOY MARE



JOY ROSE

B759



93 x 79 x 49 cm

C150



80 x 132 x 64 cm



Close-up of hidden wheel
Detalle de la rueda oculta de la cuna
Détail de la roue cachée du lit bébé
Detailansicht des versteckten Rades
Particolare della ruota nascosta del lettino

MATTE
FINISH



C150-M7779
60x 120 cm



633-179

B759-M7779

JOY ETNIK



BUBBLE WHITE



BUBBLE CIELO



BUBBLE GREY



BUBBLE ARENA



B754
↑ → ↻
93 x 79 x 49 cm

C181*
↑ → ↻
91 x 126,1 x 72,9 cm

* +info pages 22-23
5 stages with additional kits or accessories
5 etapas con packs o accesorios adicionales
5 étapes avec des kits ou accessoires supplémentaires
5 Etappen mit zusätzlichen Kits und Zubehör
5 fasi con packs o accessori opzionali



BUBBLE



C181-M7752 + WJB180-M77
(pages 22-23)



633-112

B754-M7752



BUBBLE CORAL





BUBBLE



633-055

B754-M7755



C181-M7755
60x 120 cm

BUBBLE MINT

JUNIOR FURNITURE



JUNIOR FURNITURE | MOBILIARIO JUVENIL | MOBILIER BÉBÉ
BABYMÖBEL | MOBILI PER BAMBINI

BEDSIDE TABLE

BEDSIDE TABLES | MESITAS DE NOCHE
CHEVETS | NACHTTISCHE | COMODINI



QM417

↑ 63,4 cm → 61,8 cm ↻ 40 cm

- QM417-M7700
- QM417-M7778
- QM417-M7791
- QM417-M7792



PREMIUM KURVE



QM536

↑ 60,7 cm → 60 cm ↻ 45,9 cm

- QM536-M7700



EVEN



QM551

↑ 60,7 cm → 60 cm ↻ 46,2 cm

- QM551-M7700
- QM551-M7753
- QM551-M7755
- QM551-M7778
- QM551-M7781
- QM551-M7782



KUBO



QM554

↑ 60,7 cm → 60 cm ↻ 46,2 cm

- QM554-M7700
- QM554-M7751
- QM554-M7752
- QM554-M7753
- QM554-M7755
- QM554-M7778



BUBBLE



QM559

↑ 60,7 cm → 60 cm ↻ 46,2 cm

- QM559-M7700
- QM559-M7778
- QM559-M7779
- QM559-M7781
- QM559-M7782



JOY

SIZE
90x200
cm

JUNIOR BEDS



Slatted bed base
Somier de lamas
Sommer à lattes
Lattenrost
Rete a doghe



QC417

Drawers | Cajones inferiores
Tiroirs | Schubladen | Cassettoni

QC417C-M7700

Trundle bed | Cama nido
Lit gigogne | Ausziehbett | Letto estraibile

QC417N-M7700

101,7 cm 214,1 cm 101,8 cm

MATTE
FINISH

PREMIUM KURVE



QC551

Drawers | Cajones inferiores
Tiroirs | Schubladen | Cassettoni

QC551C-M7700

Trundle bed | Cama nido
Lit gigogne | Ausziehbett | Letto estraibile

QC551N-M7700

95,5 cm 206 cm 102 cm

MATTE
FINISH

KUBO



QC554

Drawers | Cajones inferiores
Tiroirs | Schubladen | Cassettoni

QC554C-M7700

Trundle bed | Cama nido
Lit gigogne | Ausziehbett | Letto estraibile

QC554N-M7700

95,5 cm 206 cm 102 cm

MATTE
FINISH

BUBBLE



QC536

Drawers | Cajones inferiores
Tiroirs | Schubladen | Cassettoni

QC536C-M7700

QC536C-M7751

QC536C-M7752

QC536C-M7753

QC536C-M7778

QC536C-M7781

Trundle bed | Cama nido
Lit gigogne | Ausziehbett | Letto estraibile

QC536N-M7700

QC536N-M7751

QC536N-M7752

QC536N-M7753

QC536N-M7778

QC536N-M7781

95,5 cm 206 cm 102 cm

MATTE
FINISH

EVEN



QC559

Drawers | Cajones inferiores
Tiroirs | Schubladen | Cassettoni

QC559C-M7700

QC559C-M7778

QC559C-M7779

QC559C-M7781

QC559C-M7782

Trundle bed | Cama nido
Lit gigogne | Ausziehbett | Letto estraibile

QC559N-M7700

QC559N-M7778

QC559N-M7779

QC559N-M7781

QC559N-M7782

95,5 cm 206 cm 102 cm

MATTE
FINISH

JOY

**Rocking function****Posición balancín**

Position balancelle
Schaukelstuhl Position
Posizione dondolo

**Fixed base. Includes 4 feet****Posición fija. Incluye 4 patas**

Position fixe. Inclut 4 pieds
Sessel Position. Inklusive 4 Füße
Posizione fissa. Include 4 piedini

**Leatherette****Polipiel**

Simili-cuir
Kunstleder
Ecopelle

**Easy to clean, just with water****Fácil limpieza con agua**

Nettoyage facile avec de l'eau
Einfaches Reinigen mit Wasser
Facilmente lavabile con acqua

**Anti-stain treatment****Tratamiento antimanchas**

Traitement anti-tache
Anti-Flecken behandelt
Trattamento antimacchia

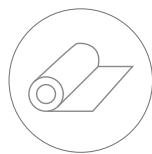
**Fabric****Tela**

Tissu
Stoff
Tessile

**Recommended height****Altura recomendada**

Hauteur conseillée
Empfohlene Grösse
Altezza consigliata

NURSING CHAIRS

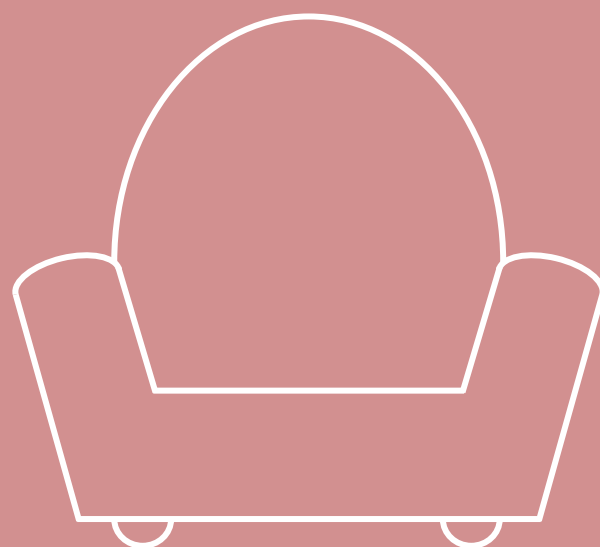

NURSING CHAIRS | SILLONES DE LACTANCIA
FAUTEUILS D'ALLAITEMENT | *STILLSESSEL* | POLTRONE ALLATTAMENTO

NURSING CHAIRS | SILLONES DE LACTANCIA
 FAUTEUILS D'ALLAITEMENT | *STILLSESSEL* | POLTRONE ALLATTAMENTO

Leatherette | Polipiel | Similicuir | *Kunstleder* | Ecopelle



SL100P-P153



SL100P-P178



SL100P-P977

Leatherette | Polipiel | Similicuir | *Kunstleder* | Ecopelle



SL100A-A901

Fabric | Tela | Tissu | Stoff | Tessuto



SL100T-T923



SL100T-T939

DETAILS | DETALLES | DÉTAILS | DETAILS | DETTAGLI



Rocking function
 Posición balancín
 Position balancelle
Schaukelstuhl Position
 Posizione dondolo



Fixed base. Includes 4 feet.
 Posición fija. Incluye 4 patas.
 Position fixe. Includ 4 pieds.
Sessel Position. Inklusive 4 Füße.
 Posizione fissa. Include 4 piedini.

MEASURES | MEDIDAS
 MESURES | *MAÛE* | MISURE

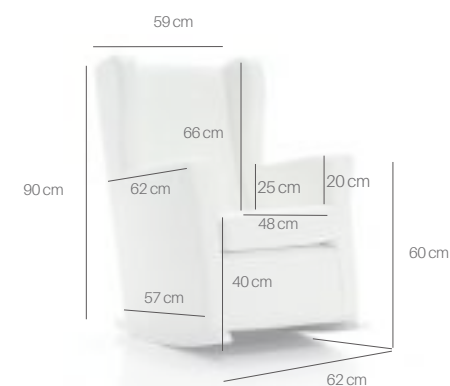



Colour chart pages 166-168
Carta de colores págs. 166-168
Nuancier pages 166-168
Farbenkarte seiten 166-168
Tabella colori pagine 166-168

NURSING CHAIRS | SILLONES DE LACTANCIA
 FAUTEUILS D'ALLAITEMENT | *STILLSESSEL* | POLTRONE ALLATTAMENTO

Leatherette | Polipiel | Similicuir | *Kunstleder* | Ecopelle



ERGO
SL101P-P153

ERGO PLUS +
SL102P-P153



ERGO
SL101P-P178

ERGO PLUS +
SL102P-P178



ERGO
SL101P-P977

ERGO PLUS +
SL102P-P977

Leatherette | Polipiel | Similicuir | *Kunstleder* | Ecopelle



ERGO
SL101A-A901

ERGO PLUS +
SL102A-A901

Fabric | Tela | Tissu | Stoff | Tessuto



ERGO
SL101T-T923

ERGO PLUS +
SL102T-T923



ERGO
SL101T-T939

ERGO PLUS +
SL102T-T939

DETAILS | DETALLES | DÉTAILS | DETAILS | DETTAGLI



Rocking function
 Posición balancín
 Position balancelle
Schaukelstuhl Position
 Posizione dondolo



Fixed base. Includes 4 feet.
 Posición fija. Incluye 4 patas.
 Position fixe. Includ 4 pieds.
Sessel Position. Inklusiv 4 Füße.
 Posizione fissa. Include 4 piedini.

MEASURES | MEDIDAS | MESURES | MAßE | MISURE

ERGO



ERGO PLUS +





Colour chart pages 166-168
Carta de colores págs. 166-168
Nuancier pages 166-168
Farbenkarte seiten 166-168
Tabella colori pagine 166-168

NURSING CHAIRS | SILLONES DE LACTANCIA
 FAUTEUILS D'ALLAITEMENT | *STILLSESSEL* | POLTRONE ALLATTAMENTO

Leatherette | Polipiel | Similicuir | *Kunstleder* | Ecopelle



SL119P-178B



SL119P-977B

Fabric | Tela | Tissu | *Stoff* | Tessile



SL119T-052B

Fabric | Tela | Tissu | *Stoff* | Tessuto



SL119T-053B



SL119T-055B



SL119T-078B

DETAILS | DETALLES | DÉTAILS | *DETAILS* | DETTAGLI



2 positions (fixed and rocking)
2 posiciones (fija y balancin)
 2 positions (fixe et ballancelle)
 2 positionen (sessel / schaukelstuhl)
 2 posizioni (fissa e dondolo)

MEASURES | MEDIDAS | MESURES | *MAßE* | MISURE

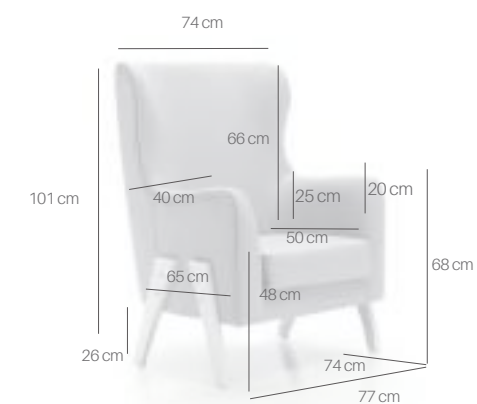



GLAM

WHITE



SL119P-178B



SL119T-078B



Colour chart pages 166-168
Carta de colores págs. 166-168
Nuancier pages 166-168
Farbenkarte seiten 166-168
Tabella colori pagine 166-168

NURSING CHAIRS | SILLONES DE LACTANCIA
 FAUTEUILS D'ALLAITEMENT | *STILLSESSEL* | POLTRONE ALLATTAMENTO

Leatherette | Polipiel | Similicuir | *Kunstleder* | Ecopelle



SL119P-178N



SL119P-977N

Fabric | Tela | Tissu | *Stoff* | Tessuto



SL119T-052N

Fabric | Tela | Tissu | *Stoff* | Tessuto



SL119T-053N



SL119T-055N



SL119T-078N

DETAILS | DETALLES | DÉTAILS | *DETAILS* | DETTAGLI



2 positions (fixed and rocking)
 2 posiciones (fija y balancin)
 2 positions (fixe et ballancelle)
 2 positionen (sessel / schaukelstuhl)
 2 posizioni (fissa e dondolo)

MEASURES | MEDIDAS | MESURES | *MAßE* | MISURE

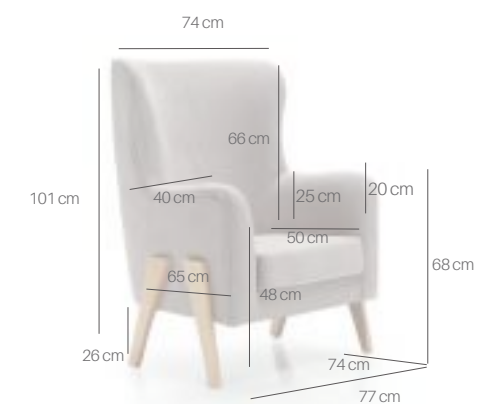



GLAM

LIFE



SL119T-078N

Colour chart pages 166-168
Carta de colores págs. 166-168
Nuancier pages 166-168
Farbenkarte seiten 166-168
Tabella colori pagine 166-168





SP105P-P153



SP105P-P178



SP105P-P977



SP105A-A901



SP105T-T923



SP105T-T939

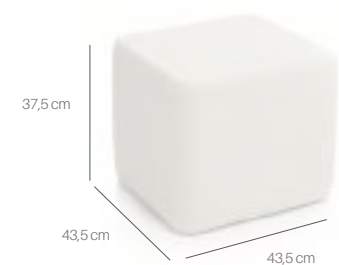

NURSERY LIGHTING

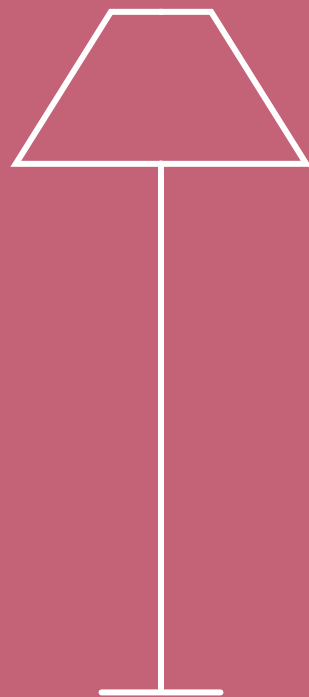

LAMPS | LÁMPARAS | LAMPES | *LAMPEN* | LAMPADE

STELLA

LAMPS | LÁMPARAS | LAMPES | LAMPEN | LAMPADE

Pendant light | Lámpara de techo | Suspension | Hängelampe | Lampadario

20 x 40 x 40 cm



L597T-0153



L597T-0178



L597T-7900



L597T-8100



L597T-8200

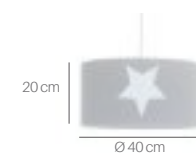

Table lamp | Lámpara de sobremesa | Lampe de chevet | Nachttischlampe | Lampada da tavolo

33,5 x 20 x 20 cm



LS597M-0153



LS597M-0178



LS597M-7900



LS597M-8100



LS597M-8200

Max.
240 V



L597M-0153

L597M-0178

L597M-7900

L597M-8100

L597M-8200



Floor lamp | Lámpara de pie | Lampadaire | Stehlampe | Lampada piantana

146 x 40 x 40 cm



L597S-0153



L597S-0178



L597S-7900



L597S-8100



L597S-8200

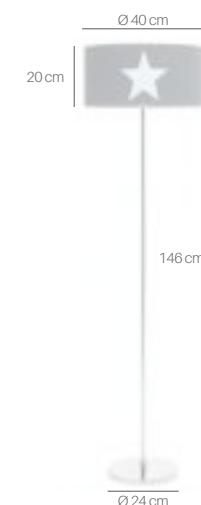

LAMPS | LÁMPARAS | LAMPES | LAMPEN | LAMPADE

Ceiling lamp | Lámpara de techo | Suspension | Deckenlampe | Lampadario

15 x 40 x 40 cm



L591T-5100



L591T-5300



L591T-7800



L591T-8100



L591T-8200

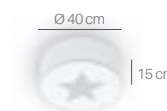

Wall lamp | Lámpara de pared | Applique murale | Wandlampe | Lampada applique

40 x 40 x 15 cm



L591P-5100



L591P-5300



L591P-7800



L591P-8100



L591P-8200

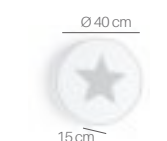

Table lamp | Lámpara de sobremesa | Lampe de chevet | Nachttischlampe | Lampada da tavolo

35 x 14 x 14 cm



LS591M-5100



LS591M-5300



LS591M-7800



LS591M-8100



LS591M-8200



LS591M-0179



Max.
240 V

12V



Child safe

L591M-5100

L591M-5300

L591M-7800

L591M-8100

L591M-8200

L591M-0179

Floor lamp | Lámpara de pie | Lampadaire | Stehlampe | Lampada da terra

141,5 x 20 x 20 cm



L591S-5100



L591S-5300



L591S-7800



L591S-8100



L591S-8200



L591S-0179

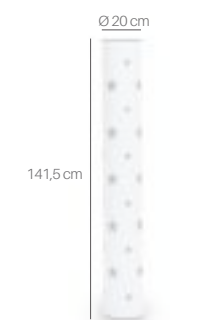

SHINE

Pendant light | Lámpara de techo
Suspension | *Hängelampe* | Lampadario

↕ ↗ ↘ 20 x 40 x 40 cm



L539-1400



L539-2300

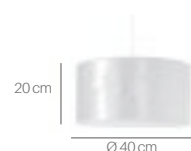

DREAMS

Pendant light | Lámpara de techo
Suspension | *Hängelampe* | Lampadario

☾ ↕ ↗ ↘ 34 x 30 x 12 cm ☆ ↕ ↗ ↘ 37 x 39 x 12 cm



L534-2070



L534-3070

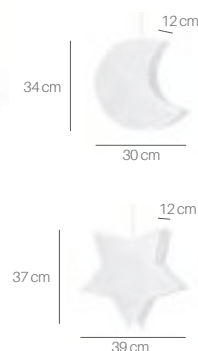

VOLARE

Wall lamp | Lámpara de pared
Applique murale | *Wandlampe* | Lampada applique

↕ ↗ ↘ 28 x 28 x 13 cm



L599P-7700



Table lamp | Lámpara de sobremesa
Lampe de chevet | *Nachttischlampe* | Lampada da tavolo

↕ ↗ ↘ 35 x 20 x 20 cm



L537-1400



L537-2300

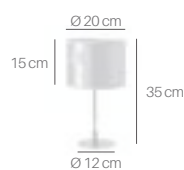

Table lamp | Lámpara de sobremesa
Lampe de chevet | *Nachttischlampe* | Lampada da tavolo

☾ ↕ ↗ ↘ 40 x 18 x 12 cm ☆ ↕ ↗ ↘ 35 x 24 x 12 cm



L532-2070



L532-3070

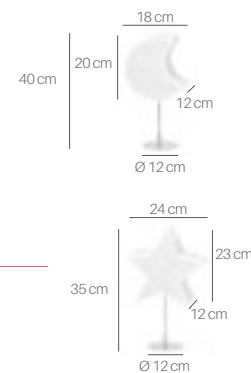
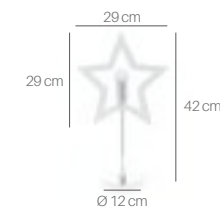

Table lamp | Lámpara de sobremesa
Lampe de chevet | *Nachttischlampe* | Lampada da tavolo

↕ ↗ ↘ 42 x 29 x 12 cm



L599M-7700



Floor lamp | Lámpara de pie | Lampadaire | *Stehlampe* | Lampada piantana

↕ ↗ ↘ 150 x 40 x 40 cm



L538-1400



L538-2300

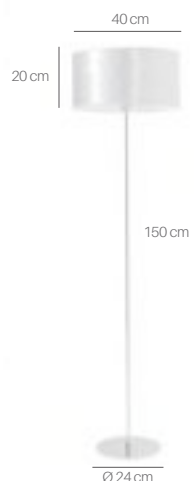

Floor lamp | Lámpara de pie | Lampadaire | *Stehlampe* | Lampada piantana

☾ ↕ ↗ ↘ 164 x 30 x 12 cm ☆ ↕ ↗ ↘ 156 x 39 x 12 cm



L533-2070



L533-3070

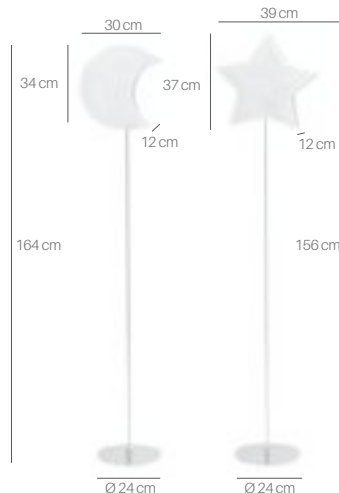

Pendant light | Lámpara de techo
Suspension | *Hängelampe* | Lampadario

↕ ↗ ↘ 52 x 52 cm



L599T-7700



MDF **MDF star** | Estrella en MDF
Étoile en MDF | *Stern aus MDF* | Stella in MDF

TOYS



TOYS | JUGUETES | JOUETS | SPIELZEUGE | GIOCATTOLI

RIDER

U31CBR-7700



WOODEN HORSES WITH WHEELS | CABALLITOS DE MADERA CON RUEDAS
CHEVAUX DE BOIS À ROULETTES | HOLZPFERDE AUF ROLLEN | CAVALLI DI LEGNO CON RUOTE

U31CBR-7751



U31CBR-7752



U31CBR-7753



U31CBR-7755



U31CBR-7778



MEASURES | MEDIDAS
MESURES | MAßE | MISURE



ROCKING HORSES | CABALLITOS BALANCÍN
CHEVAUX À BASCULE | SCHAUKELPFERDE | CAVALLI A DONDOLO

U32CBB-7700



U32CBB-7751



U32CBB-7752



U32CBB-7753



U32CBB-7755



U32CBB-7778



ROCKY

MEASURES | MEDIDAS
MESURES | MAßE | MISURE



WIND

WOODEN PLANES | AVIONES DE MADERA
AVIONS EN BOIS | HOLZFLUGZEUGE | AEREI DI LEGNO

U34AVI-7700



U34AVI-7751



U34AVI-7753



U34AVI-7755



U34AVI-7778



MEASURES | MEDIDAS
MESURES | MÄßE | MISURE

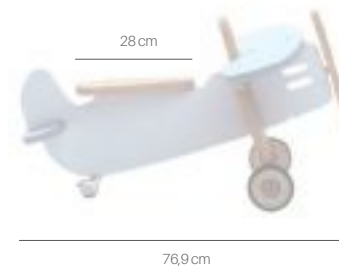

DESK & CHAIR | ESCRITORIO Y SILLA
BUREAU ET CHAISE | SCHREIBTISCH UND STUHL | CASETTA/SCRIVANIA E SGABELLO

U33MES-7700



U33MES-7751



U33MES-7752



U33MES-7753



U33MES-7755



U33MES-7778



MEASURES | MEDIDAS
MESURES | MAßE | MISURE

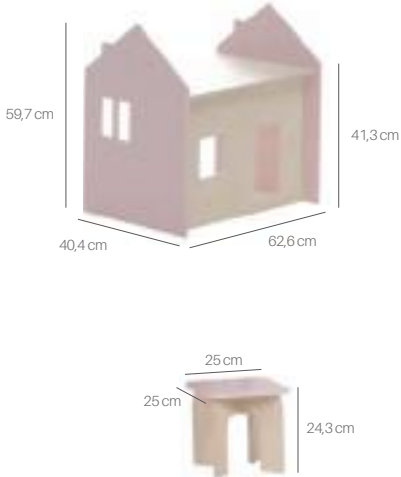

PRINCESS

DOLL'S PRAM | CARRITO BEBÉ
POUSSETTE POUR POUPEE | PUPPENWAGEN | PASSEGGINO PER BAMBOLE

U36CRT-7700



U36CRT-7752



PRIX

WOODEN MOTORBIKE | MOTO DE MADERA INFANTIL
MOTO EN BOIS | HOLZMOTORRAD | MOTO GIOCATTOLO DI LEGNO

U35MOT-7700



MEASURES | MEDIDAS
MESURES | MAßE | MISURE

Doll's pram | Carrito de bebé | Poussette pour poupée
Puppenwagen | Passeggino per bambole

Motorbike | Moto | Moto en bois
Holzmotorrad | Moto giocattolo di legno



1205-520
35 x 46 x 14 cm

4in1

Carry all diaper bag
Bolso maternidad
Sac à langer en bandoulière
Wickeltasche Schultertasche
Borsa mamma

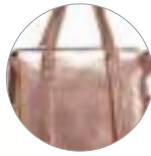

1207-520
38 x 46 x 15 cm

4in1

Carry all diaper bag
Bolso maternidad
Sac à langer en bandoulière
Wickeltasche Schultertasche
Borsa mamma



1400-520
9 x 9 x 9 cm

Pacifier holder
Portachupete
Porte sucette
Schnullertasche
Portaciuccio



1500-520
22 x 9 x 9 cm

Bottle holder
Portabiberón
Porte biberon
Fläschchentasche
Portabiberon



1601-520
26 x 18 x 2 cm (closed)
26 x 36 x 2 cm (open)

Document holder
Portadocumentos
Porte-documents
Dokumententasche
Portadocumenti



1702-520

21 x 24 x 3 cm (closed)
58 x 44 x 3 cm (open)

Changing mat
Cambiador Bebé
Matelas à langer
Reise-Wickelunterlage
Fasciatoio da viaggio



1900-520
19 x 30 x 8 cm

Toiletry bag
Neceser
Trousse de toilette
Kulturbeutel
Trousse toilette



Waterproof lining | Forro interior impermeable
Doublure intérieure imperméable | Inneres Futter wasserdicht
Fodera interna impermeabile



Leatherette | Polipiel
Simili-cuir | Kunstleder
Ecopelle



ROSEGOLD



1205-521
35 x 46 x 14 cm

4in1

Carry all diaper bag
Bolso maternidad
Sac à langer en bandoulière
Wickeltasche Schultertasche
Borsa mamma

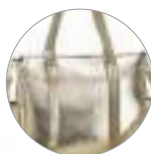

1207-521
38 x 46 x 15 cm

4in1

Carry all diaper bag
Bolso maternidad
Sac à langer en bandoulière
Wickeltasche Schultertasche
Borsa mamma



1400-521
9 x 9 x 9 cm

Pacifier holder
Portachupete
Porte sucette
Schnullertasche
Portaciuccio



1500-521
22 x 9 x 9 cm

Bottle holder
Portabiberón
Porte biberon
Fläschchentasche
Portabiberon



1601-521
26 x 18 x 2 cm (closed)
26 x 36 x 2 cm (open)

Document holder
Portadocumentos
Porte-documents
Dokumententasche
Portadocumenti



1702-521

21 x 24 x 3 cm (closed)
58 x 44 x 3 cm (open)

Changing mat
Cambiador Bebé
Matelas à langer
Reise-Wickelunterlage
Fasciatoio da viaggio



1900-521
19 x 30 x 8 cm

Toiletry bag
Neceser
Trousse de toilette
Kulturbeutel
Trousse toilette



Waterproof lining | Forro interior impermeable
Doublure intérieure imperméable | Inneres Futter wasserdicht
Fodera interna impermeabile



Leatherette | Polipiel
Simili-cuir | Kunstleder
Ecopelle



CHAMPAGNE



1205-522
35 x 46 x 14 cm

4in1

Carry all diaper bag
Bolso maternidad
Sac à langer en bandoulière
Wickeltasche Schultertasche
Borsa mamma



1207-522
38 x 46 x 15 cm

4in1

Carry all diaper bag
Bolso maternidad
Sac à langer en bandoulière
Wickeltasche Schultertasche
Borsa mamma



1400-522
9 x 9 x 9 cm

Pacifier holder
Portachupete
Porte sucette
Schnullertasche
Portaciuccio



1500-522
22 x 9 x 9 cm

Bottle holder
Portabiberón
Porte biberon
Fläschchentasche
Portabiberon



1601-522
26 x 18 x 2 cm (closed)
26 x 36 x 2 cm (open)

Document holder
Portadocumentos
Porte-documents
Dokumententasche
Portadocumenti



1702-522

21 x 24 x 3 cm (closed)
58 x 44 x 3 cm (open)

Changing mat
Cambiador Bebé
Matelas à langer
Reise-Wickelunterlage
Fasciatoio da viaggio



1900-522
19 x 30 x 8 cm

Toiletry bag
Neceser
Trousse de toilette
Kulturbeutel
Trousse toilette



Waterproof lining | Forro interior impermeable
Doublure intérieure imperméable | Inneres Futter wasserdicht
Fodera interna impermeabile



Leatherette | Polipiel
Simili-cuir | Kunstleder
Ecopelle





1205-529
35 x 46 x 14 cm

4in1

Carry all diaper bag
Bolso maternidad
Sac à langer en bandoulière
Wickeltasche Schultertasche
Borsa mamma



1207-529
38 x 46 x 15 cm

4in1

Carry all diaper bag
Bolso maternidad
Sac à langer en bandoulière
Wickeltasche Schultertasche
Borsa mamma



1400-529
9 x 9 x 9 cm

Pacifier holder
Portachupete
Porte sucette
Schnullertasche
Portaciuccio



1500-522
22 x 9 x 9 cm

Bottle holder
Portabiberón
Porte biberon
Fläschchentasche
Portabiberon



1601-522
26 x 18 x 2 cm (closed)
26 x 36 x 2 cm (open)

Document holder
Portadocumentos
Porte-documents
Dokumententasche
Portadocumenti



1702-522

21 x 24 x 3 cm (closed)
58 x 44 x 3 cm (open)

Changing mat
Cambiador Bebé
Matelas à langer
Reise-Wickelunterlage
Fasciatoio da viaggio



1900-522
19 x 30 x 8 cm

Toiletry bag
Neceser
Trousse de toilette
Kulturbeutel
Trousse toilette



Waterproof lining | Forro interior impermeable
Doublure intérieure imperméable | Inneres Futter wasserdicht
Fodera interna impermeabile



Leatherette | Polipiel
Simili-cuir | Kunstleder
Ecopelle





UP&DOWN BLU

BAGS | BOLSOS | SACS | TASCHEN | BORSE

1100-751

33 x 41 x 13 cm

Tote diaper bag

Bolso panera

Sac à langer

Wickeltasche Tote-Bag

Borsa passeggio

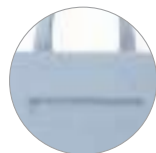

1400-751

9 x 9 x 9 cm

Pacifier holder

Portachupete

Porte sucette

Schnullertasche

Portaciuccio



1702-751

21 x 24 x 3 cm (closed)
58 x 44 x 3 cm (open)

Changing mat

Cambiador Bebé

Matelas à langer

Reise-Wickelunterlage

Fasciatoio da viaggio



1202-751

32 x 42 x 12 cm

Carry all diaper bag

Bolso maternidad

Sac à langer en bandoulière

Wickeltasche Schultertasche

Borsa mamma

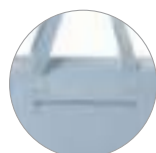
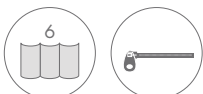

1500-751

22 x 9 x 9 cm

Bottle holder

Portabiberón

Porte biberon

Fläschchentasche

Portabiberon



1900-751

19 x 30 x 8 cm

Toiletry bag

Necesar

Trousse de toilette

Kulturbeutel

Trousse toilette



1300-751

35 x 31 x 14 cm

Backpack diaper bag

Mochila maternal

Sac à dos à langer

Wickeltasche Rucksack

Zainetto mamma



1601-751

26 x 18 x 2 cm (closed)
26 x 36 x 2 cm (open)

Document holder

Portadocumentos

Porte-documents

Dokumententasche

Portadocumenti



Waterproof lining | Forro interior impermeabile

doublure intérieure imperméable | *Innere Futter wasserdicht*
Fodera interna impermeabile



Leatherette | Polipiel
Simili-cuir | *Kunstleder*
Ecopelle



ONDA WHITE

BAGS | BOLSOS | SACS | TASCHEN | BORSE

1100-777

33 x 41 x 13 cm

Tote diaper bag
Bolso panera
 Sac à langer
Wickeltasche Tote-Bag
 Borsa passeggio



1400-777

9 x 9 x 9 cm

Pacifier holder
Portachupete
 Porte sucette
Schnullertasche
 Portaciuccio



1702-777

21 x 24 x 3 cm (closed)
 58 x 44 x 3 cm (open)

Changing mat
Cambiador Bebé
 Matelas à langer
Reise-Wickelunterlage
 Fasciatoio da viaggio



1202-777

32 x 42 x 12 cm

Carry all diaper bag
Bolso maternidad
 Sac à langer en bandoulière
Wickeltasche Schultertasche
 Borsa mamma



1500-777

22 x 9 x 9 cm

Bottle holder
Portabiberón
 Porte biberon
Fläschchentasche
 Portabiberon



1900-777

19 x 30 x 8 cm

Toiletry bag
Necesar
 Trousse de toilette
Kulturbeutel
 Trousse toilette



1300-777

35 x 31 x 14 cm

Backpack diaper bag
Mochila maternal
 Sac à dos à langer
Wickeltasche Rucksack
 Zainetto mamma



1601-777

26 x 18 x 2 cm (closed)
 26 x 36 x 2 cm (open)

Document holder
Portadocumentos
 Porte-documents
Dokumententasche
 Portadocumenti



Waterproof lining | Forro interior impermeable
 Doublure intérieure imperméable | *Inneres Futter wasserdicht*
 Fodera interna impermeabile



Leatherette | Polipiel
 Simili-cuir | *Kunstleder*
 Ecopelle



ONDA ARENA

BAGS | BOLSOS | SACS | TASCHEN | BORSE

1100-753

33 x 41 x 13 cm

Tote diaper bag

Bolso panera

Sac à langer

Wickeltasche Tote-Bag

Borsa passeggio

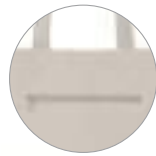
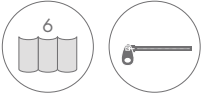

1400-753

9 x 9 x 9 cm

Pacifier holder

Portachupete

Porte sucette

Schnullertasche

Portaciuccio



1702-753

21 x 24 x 3 cm (closed)
58 x 44 x 3 cm (open)

Changing mat

Cambiador Bebé

Matelas à langer

Reise-Wickelunterlage

Fasciatoio da viaggio



1202-753

32 x 42 x 12 cm

Carry all diaper bag

Bolso maternidad

Sac à langer en bandoulière

Wickeltasche Schultertasche

Borsa mamma

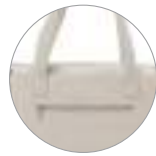
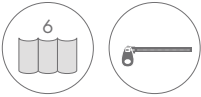

1500-753

22 x 9 x 9 cm

Bottle holder

Portabiberón

Porte biberon

Fläschchentasche

Portabiberon



1900-753

19 x 30 x 8 cm

Toiletry bag

Necesar

Trousse de toilette

Kulturbeutel

Trousse toilette



1300-753

35 x 31 x 14 cm

Backpack diaper bag

Mochila maternal

Sac à dos à langer

Wickeltasche Rucksack

Zainetto mamma



1601-753

26 x 18 x 2 cm (closed)
26 x 36 x 2 cm (open)

Document holder

Portadocumentos

Porte-documents

Dokumententasche

Portadocumenti



Waterproof lining | Forro interior impermeable

doublure intérieure imperméable | *Inneres Futter wasserdicht*

Fodera interna impermeabile



Leatherette | Polipiel

Simili-cuir | *Kunstleder*

Ecopelle



UP&DOWN ROSA

BAGS | BOLSOS | SACS | TASCHEN | BORSE

1100-752
33 x 41 x 13 cm

Tote diaper bag
Bolso panera
Sac à langer
Wickeltasche Tote-Bag
Borsa passeggio



1400-752
9 x 9 x 9 cm

Pacifier holder
Portachupete
Porte sucette
Schnullertasche
Portaciuccio



1702-752

21 x 24 x 3 cm (closed)
58 x 44 x 3 cm (open)

Changing mat
Cambiador Bebé
Matelas à langer
Reise-Wickelunterlage
Fasciatoio da viaggio



1202-752
32 x 42 x 12 cm

Carry all diaper bag
Bolso maternidad
Sac à langer en bandoulière
Wickeltasche Schultertasche
Borsa mamma



1500-752
22 x 9 x 9 cm

Bottle holder
Portabiberón
Porte biberon
Fläschchentasche
Portabiberon



1900-752
19 x 30 x 8 cm

Toiletry bag
Necesar
Trousse de toilette
Kulturbeutel
Trousse toilette



1300-752
35 x 31 x 14 cm

Backpack diaper bag
Mochila maternal
Sac à dos à langer
Wickeltasche Rucksack
Zainetto mamma



1601-752
26 x 18 x 2 cm (closed)
26 x 36 x 2 cm (open)

Document holder
Portadocumentos
Porte-documents
Dokumententasche
Portadocumenti



Waterproof lining | Forro interior impermeable
Doublure intérieure imperméable | Inneres Futter wasserdicht
Fodera interna impermeabile



Leatherette | Polipiel
Simili-cuir | Kunstleder
Ecopelle





Number of pieces
Número de piezas
Nombre de pièces
Anzahl der Teile
Numero di pezzi



Removable without zipper
Desenfundable sin cremallera
Déhoussable sans fermeture éclair
Abziehbar ohne Reißverschluss
Sfoderabile senza chiusura zip



Removable with zipper
Desenfundable con cierre de cremallera
Déhoussable avec fermeture éclair
Abziehbar mit Reißverschluss
Sfoderabile con chiusura zip



Number of pennants
Número de banderines
Nombre de banderoles
Anzahl der Wimpel
Numero di bandierine

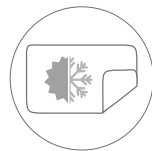

Double-sided for winter & summer
Doble cara. Invierno-verano
Double face hiver-été
Winter -und Sommerseite
Double face inverno-estate

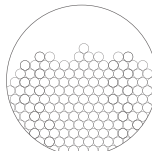

Polystyrene beads filling
Relleno con perlas de poliestireno
Rembourrage billes de polystyrène
Füllung aus Polystyrenkugeln
Imbottito con perle di polistirolo



Velcro closure
Cierre con velcro
Fermeture en scratch
Klettverschluss
Chiusura velcro

TEXTILES

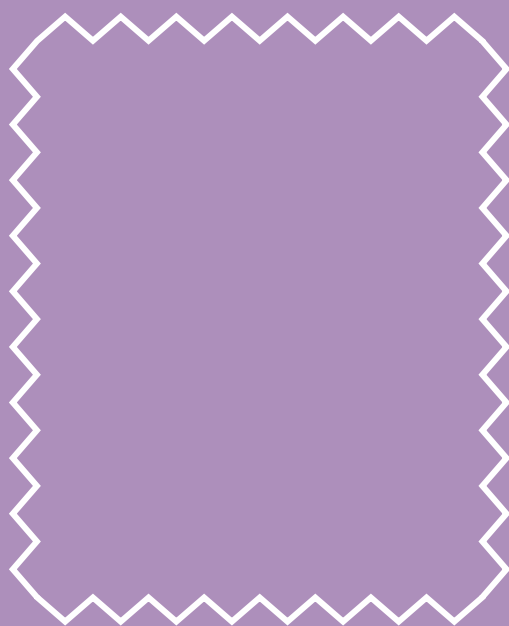

TEXTILES | TEXTILES | LAYETTE | *TEXTILIEN* | TESSILE

689-055

36 x 43 x 12 cm

Kids cushion · Mountains
Cojín infantil · Montañas
Coussin enfant · Montagnes
Kinder-Kissen · Berge
Cuscino decorativo · Montagna



691-055

36 x 32 x 10 cm

Kids cushion · Teepee tent
Cojín infantil · Tipi
Coussin enfant · Tipi
Kinder-Kissen · Tipi
Cuscino decorativo · Tenda



692E-055

35 x 43 x 11 cm

Kids cushion · Triangle
Cojín infantil · Triángulo
Coussin enfant · Triangle
Kinder-Kissen · Dreieck
Cuscino decorativo · Triangolo



692L-900

35 x 43 x 11 cm

Kids cushion · Triangle
Cojín infantil · Triángulo
Coussin enfant · Triangle
Kinder-Kissen · Dreieck
Cuscino decorativo · Triangolo



694-055

▼ 18 x 12 cm

Garland-pennants (2,50 m long)
Guirnalda-banderines infantiles (2,50 m largo)
Guirlande-banderole (2,50 m longueur)
Stoff-Girlande (2,50 m lang)
Ghirlanda-bandierine (2,50 m. lunghezza)



693-055

☆ 34 x 34 x 10 cm ♥ 20 x 20 x 8 cm ☾ 26 x 20 x 8 cm

Set 3 decorative cushions
Set 3 cojines infantiles decoración
Set 3 coussins décoratifs
Set 3 Dekokissen
Set 3 cuscini da decorazione



618-055

21 x 30 x 20 cm

Padded baby toiletries basket
Cesta colonias infantil acolchada
Panier matelassé pour produits de soin
Gefütterter Stoffkorb für Badeartikel
Cestino portasaponi trapuntato



690E-055

35 x 35 x 15 cm

Square cushion with removable cover
Cojín infantil cuadrado desfundable
Coussin carré déhoussable
Quadratisches Kissen (abziehbar)
Cuscino quadrato sfoderabile



631-055

15 x 60 x 90 cm

Top changer for Konver 70x140 and chest
Vestidor para Konver 70x140 y cómoda
Matelas à langer pour Konver 70x140 et commode
Wickelaufgabe für Konver 70x140 und Kommode
Fasciatoio Konver 70x140 e cassetiera



633-055*

10 x 51 x 82 cm

Bath changer cover without foam
Funda vestidor sin espuma para bañeras
Housse supplémentaire sans mousse pour baignoires
Bezug für Wickelaufgabe ohne Schaumstoff für Waschtisch
Fodera fasciatoio (senza materassino) per bagnetti



634-055

8 x 46 x 65 cm

Top changer for Konver 60x120
Vestidor para Konver 60x120
Matelas à langer pour Konver 60x120
Wickelaufgabe für Konver 60x120
Fasciatoio Konver 60x120



619-055

41 x 34 x 34 cm

Padded fabric storage basket
Saco de juguetes textil acolchado
Panier de rangement matelassé
Gefütterter Korb für Spielwaren
Sacco portagiochi trapuntato



* Inside foam ref. R-VE1 not included | Espuma interior Ref. R-VE1, no incluida
Mousse intérieure Réf. R-VE1 pas incluse | Wickelaufgabe Ref. R-VE1 nicht inklusive | Materassino Rif. R-VE1, non incluso

Sizes | Medidas | Misure | Wisure | Misure ↕ → ↻

MINT 055



60x120

606-055

92 x 140 cm

70x140

626-055

105 x 165 cm

90x200

636-055

155 x 250 cm

Duvet cover (with duvet)
Nórdico (con relleno)
 Housse et couette
Bettbezug (mit Decke)
 Piumino nordico (con imbottitura)



60x120

606F-055

92 x 140 cm

70x140

626F-055

105 x 165 cm

90x200

636F-055

155 x 250 cm

Duvet cover (without duvet)
Funda nórdica (sin relleno)
 Housse pour couette
Bettbezug (ohne Decke)
 Sacco nordico (senza imbottitura)

60x120

607-055

180 x 44 cm

70x140

627-055

210 x 44 cm

Bumper Protector
 Tour de lit
Nestchen
 Paracolpi



646-055

132 x 115 x 115 cm

Kids tepee tent
Tipi infantil
 Tipi enfant
 Tipi- Kinderzelt
 Tenda indiana



60x120

612-055

110 x 150 cm

70x140

632-055

135 x 175 cm

Cot sheets set - 3 pieces (100% Cotton)
Sábanas cuna - 3 piezas (100% Algodón)
 Parure de lit - 3 pièces (100% Coton)
Bettwäsche - 3 tlg. (100% Baumwolle)
 Lenzuola lettino - 3 pezzi (100% Cotone)



616-055

95 x 122 cm

Crib sheets set - 3 pieces (100% Cotton)
Sábanas minicuna - 3 piezas (100% Algodón)
 Parure de berceau - 3 pièces (100% Coton)
Bettwäsche für Wiege 3-tlg. (100% Baumwolle)
 Lenzuola culla - 3 pezzi (100% Cotone)



698-055

8 x 29 x 26 cm
 8 x 42 x 26 cm

Sleep positioner with removable cover
Cojín Antivelco bebé desenfundable
 Cale-bébé déhoussable
Seitenschläferkissen (abziehbar)
 Riduttore dormisicuro sfoderabile



647-055

115 x 115 cm

Carpet for tepee tent
Alfombra para Tipi infantil
 Tapis pour tipi
Teppich für Tipi- Kinderzelt
 Tappeto per tenda indiana



689-111

36 x 43 x 12 cm

Kids cushion · Mountains
Cojín infantil · Montañas
Coussin enfant · Montagnes
Kinder-Kissen · Berge
Cuscino decorativo · Montagna



691-111

36 x 32 x 10 cm

Kids cushion · Teepee tent
Cojín infantil · Tipi
Coussin enfant · Tipi
Kinder-Kissen · Tipi
Cuscino decorativo · Tenda



692E-111

35 x 43 x 11 cm

Kids cushion · Triangle
Cojín infantil · Triángulo
Coussin enfant · Triangle
Kinder-Kissen · Dreieck
Cuscino decorativo · Triangolo



692L-901

35 x 43 x 11 cm

Kids cushion · Triangle
Cojín infantil · Triángulo
Coussin enfant · Triangle
Kinder-Kissen · Dreieck
Cuscino decorativo · Triangolo



694-111

▼ 18 x 12 cm

Garland-pennants (2,50 m long)
Guirnalda-banderines infantiles (2,50 m largo)
Guirlande-banderole (2,50 m longueur)
Stoff-Girlande (2,50 m lang)
Ghirlanda-bandierine (2,50 m. lunghezza)



693-111

☆ 34 x 34 x 10 cm ♥ 20 x 20 x 8 cm ☾ 26 x 20 x 8 cm

Set 3 decorative cushions
Set 3 cojines infantiles decoración
Set 3 coussins décoratifs
Set 3 Dekokissen
Set 3 cuscini da decorazione



618-111

21 x 30 x 20 cm

Padded baby toiletries basket
Cesta colonias infantil acolchada
Panier matelassé pour produits de soin
Gefütterter Stoffkorb für Badeartikel
Cestino portasaponi trapuntato



690E-111

35 x 35 x 15 cm

Square cushion with removable cover
Cojín infantil cuadrado desenfundable
Coussin carré déhoussable
Quadratisches Kissen (abziehbar)
Cuscino quadrato sfoderabile

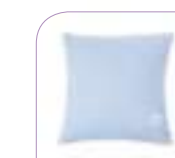

690L-111
Blue | Celeste
Bleu | Blau | Celeste

631-111

15 x 60 x 90 cm

Top changer for Konver 70x140 and chest
Vestidor para Konver 70x140 y cómoda
Matelas à langer pour Konver 70x140 et commode
Wickelaufgabe für Konver 70x140 und Kommode
Fasciatoio Konver 70x140 e cassetiera



633-111*

10 x 51 x 82 cm

Bath changer cover without foam
Funda vestidor sin espuma para bañeras
Housse supplémentaire sans mousse pour baignoires
Bezug für Wickelaufgabe ohne Schaumstoff für Waschtisch
Fodera fasciatoio (senza materassino) per bagnetti



634-111

8 x 46 x 65 cm

Top changer for Konver 60x120
Vestidor para Konver 60x120
Matelas à langer pour Konver 60x120
Wickelaufgabe für Konver 60x120
Fasciatoio Konver 60x120



619-111

41 x 34 x 34 cm

Padded fabric storage basket
Saco de juguetes textil acolchado
Panier de rangement matelassé
Gefütterter Korb für Spielwaren
Sacco portagiochi trapuntato



* Inside foam ref. R-VE1 not included | Espuma interior Ref. R-VE1, no incluida
Mousse intérieure Réf. R-VE1 pas incluse | Wickelaufgabe Ref. R-VE1 nicht inklusive | Materassino Rif. R-VE1, non incluso

INDIANA BLU 111



606-111 60x120
92 x 140 cm

626-111 70x140
105 x 165 cm

636-111 90x200
155 x 250 cm

Duvet cover (with duvet)
Nórdico (con relleno)
Housse et couette
Bettbezug (mit Decke)
Piumino nordico (con imbottitura)

606F-111 60x120
92 x 140 cm

626F-111 70x140
105 x 165 cm

636F-111 90x200
155 x 250 cm

Duvet cover (without duvet)
Funda nórdica (sin relleno)
Housse pour couette
Bettbezug (ohne Decke)
Sacco nordico (senza imbottitura)



Co-sleeping crib & textile set (+ info pages 6-7)
Minicuna de colecho y Kit textil (+ info págs. 6-7)
Berceau cododo + kit textile (+ info pages 6-7)
Beistellbett + Textil-Set (+ Info auf Seiten 6-7)
Culla fianco letto + pack tessile (+ info pages. 6-7)

607-111 60x120
180 x 44 cm

627-111 70x140
210 x 44 cm

Bumper Protector
Tour de lit
Nestchen
Paracolpi



646-111
132 x 115 x 115 cm

Kids tepee tent
Tipi infantil
Tipi enfant
Tipi- Kinderzelt
Tenda indiana



612-111 60x120
110 x 150 cm

632-111 70x140
135 x 175 cm

Cot sheets set - 3 pieces (100% Cotton)
Sábanas cuna - 3 piezas (100% Algodón)
Parure de lit - 3 pièces (100% Coton)
Bettwäsche - 3 tlg. (100% Baumwolle)
Lenzuola lettino - 3 pezzi (100% Cotone)

616-111
95 x 122 cm

Crib sheets set - 3 pieces (100% Cotton)
Sábanas minicuna - 3 piezas (100% Algodón)
Parure de berceau - 3 pièces (100% Coton)
Bettwäsche für Wiege 3-tlg. (100% Baumwolle)
Lenzuola culla - 3 pezzi (100% Cotone)



698-111

8 x 29 x 26 cm
8 x 42 x 26 cm



Sleep positioner with removable cover
Cojín Antivelco bebé desenfundable
Cale-bébé déhoussable
Seitenschläferkissen (abziehbar)
Riduttore dormisicuro sfoderabile



647-111
115 x 115 cm

Carpet for tepee tent
Alfombra para Tipi infantil
Tapis pour tipi
Teppich für Tipi- Kinderzelt
Tappeto per tenda indiana



Set
3
pieces

689-112

36 x 43 x 12 cm

Kids cushion · Mountains
Cojín infantil · Montañas
Coussin enfant · Montagnes
Kinder-Kissen · Berge
Cuscino decorativo · Montagna



691-112

36 x 32 x 10 cm

Kids cushion · Teepee tent
Cojín infantil · Tipi
Coussin enfant · Tipi
Kinder-Kissen · Tipi
Cuscino decorativo · Tenda



692E-112

35 x 43 x 11 cm

Kids cushion · Triangle
Cojín infantil · Triángulo
Coussin enfant · Triangle
Kinder-Kissen · Dreieck
Cuscino decorativo · Triangolo



692L-902

35 x 43 x 11 cm

Kids cushion · Triangle
Cojín infantil · Triángulo
Coussin enfant · Triangle
Kinder-Kissen · Dreieck
Cuscino decorativo · Triangolo



694-112

▼ 18 x 12 cm

Garland-pennants (2,50 m long)
Guirnalda-banderines infantiles (2,50 m largo)
Guirlande-banderole (2,50 m longueur)
Stoff-Girlande (2,50 m lang)
Ghirlanda-bandierine (2,50 m. lunghezza)

▼
x16



693-112

☆ 34 x 34 x 10 cm ♥ 20 x 20 x 8 cm ☾ 26 x 20 x 8 cm

Set 3 decorative cushions
Set 3 cojines infantiles decoración
Set 3 coussins décoratifs
Set 3 Dekokissen
Set 3 cuscini da decorazione

Set
3
pieces



618-112

21 x 30 x 20 cm

Padded baby toiletries basket
Cesta colonias infantil acolchada
Panier matelassé pour produits de soin
Gefütterter Stoffkorb für Badeartikel
Cestino portasaponi trapuntato



690E-112

35 x 35 x 15 cm

Square cushion with removable cover
Cojín infantil cuadrado desenfundable
Coussin carré déhoussable
Quadratisches Kissen (abziehbar)
Cuscino quadrato sfoderabile

▼



690L-112
Pink | Rosa
Rose | Rosa | Rosa

631-112

15 x 60 x 90 cm

Top changer for Konver 70x140 and chest
Vestidor para Konver 70x140 y cómoda
Matelas à langer pour Konver 70x140 et commode
Wickelaufgabe für Konver 70x140 und Kommode
Fasciatoio Konver 70x140 e cassetiera



633-112*

10 x 51 x 82 cm

Bath changer cover without foam
Funda vestidor sin espuma para bañeras
Housse supplémentaire sans mousse pour baignoires
Bezug für Wickelaufgabe ohne Schaumstoff für Waschtisch
Fodera fasciatoio (senza materassino) per bagnetti



634-112

8 x 46 x 65 cm

Top changer for Konver 60x120
Vestidor para Konver 60x120
Matelas à langer pour Konver 60x120
Wickelaufgabe für Konver 60x120
Fasciatoio Konver 60x120



619-112

41 x 34 x 34 cm

Padded fabric storage basket
Saco de juguetes textil acolchado
Panier de rangement matelassé
Gefütterter Korb für Spielwaren
Sacco portagiochi trapuntato



* Inside foam ref. R-VE1 not included | Espuma interior Ref. R-VE1, no incluida
Mousse intérieure Réf. R-VE1 pas incluse | Wickelaufgabe Ref. R-VE1 nicht inklusive | Materassino Rif. R-VE1, non incluso

INDIANA ROSA 112



60x120

606-112

92 x 140 cm

70x140

626-112

105 x 165 cm

90x200

636-112

155 x 250 cm

Duvet cover (with duvet)
Nórdico (con relleno)
 Housse et couette
Bettbezug (mit Decke)
 Piumino nordico (con imbottitura)

60x120

606F-112

92 x 140 cm

70x140

626F-112

105 x 165 cm

90x200

636F-112

155 x 250 cm

Duvet cover (without duvet)
Funda nórdica (sin relleno)
 Housse pour couette
Bettbezug (ohne Decke)
 Sacco nordico (senza imbottitura)



Co-sleeping crib & textile set (+ info pages 6-7)
Minicuna de colecho y Kit textil (+ info págs. 6-7)
 Berceau cododo + kit textile (+ info pages 6-7)
Beistellbett + Textil-Set (+ Info auf Seiten 6-7)
 Culla fianco letto + pack tessile (+ info pages 6-7)

60x120

607-112

180 x 44 cm

70x140

627-112

210 x 44 cm

Bumper Protector
 Tour de lit
Nestchen
 Paracolpi



646-112

132 x 115 x 115 cm

Kids teepee tent
Tipi infantil
 Tipi enfant
 Tipi- Kinderzelt
 Tenda indiana



60x120

612-112

110 x 150 cm

70x140

632-112

135 x 175 cm

Cot sheets set - 3 pieces (100% Cotton)
Sábanas cuna - 3 piezas (100% Algodón)
 Parure de lit - 3 pièces (100% Coton)
Bettwäsche - 3 tlg. (100% Baumwolle)
 Lenzuola lettino - 3 pezzi (100% Cotone)

616-112

95 x 122 cm

Crib sheets set - 3 pieces (100% Cotton)
Sábanas minicuna - 3 piezas (100% Algodón)
 Parure de berceau - 3 pièces (100% Coton)
Bettwäsche für Wiege 3-tlg. (100% Baumwolle)
 Lenzuola culla - 3 pezzi (100% Cotone)



698-112

8 x 29 x 26 cm
 8 x 42 x 26 cm

Sleep positioner with removable cover
Cojín Antivelco bebé desenfundable
 Cale-bébé déhoussable
Seitenschläferkissen (abziehbar)
 Riduttore dormisicuro sfoderabile



647-112

115 x 115 cm

Carpet for teepee tent
Alfombra para Tipi infantil
 Tapis pour tipi
Teppich für Tipi- Kinderzelt
 Tappeto per tenda indiana



Set
 3
 pieces

689-114

36 x 43 x 12 cm

Kids cushion · Mountains
Cojín infantil · Montañas
Coussin enfant · Montagnes
Kinder-Kissen · Berge
Cuscino decorativo · Montagna



691-114

36 x 32 x 10 cm

Kids cushion · Teepee tent
Cojín infantil · Tipi
Coussin enfant · Tipi
Kinder-Kissen · Tipi
Cuscino decorativo · Tenda



690E-114G

35 x 35 x 15 cm

Square cushion with removable cover
Cojín infantil cuadrado desenfundable
Coussin carré déhoussable
Quadratisches Kissen (abziehbar)
Cuscino quadrato sfoderabile



694-114

▼ 18 x 12 cm

Garland-pennants (2,50 m long)
Guiraldas-banderines infantiles (2,50 m largo)
Guirlande-banderole (2,50 m longueur)
Stoff-Girlande (2,50 m lang)
Ghirlanda-bandierine (2,50 m. lunghezza)



693-114

☆ 34 x 34 x 10 cm ♥ 20 x 20 x 8 cm ☾ 26 x 20 x 8 cm

Set 3 decorative cushions
Set 3 cojines infantiles decoración
Set 3 coussins décoratifs
Set 3 Dekokissen
Set 3 cuscini da decorazione



690E-114B

35 x 35 x 15 cm

Square cushion with removable cover
Cojín infantil cuadrado desenfundable
Coussin carré déhoussable
Quadratisches Kissen (abziehbar)
Cuscino quadrato sfoderabile



631-114

15 x 60 x 90 cm

Top changer for Konver 70x140 and chest
Vestidor para Konver 70x140 y cómoda
Matelas à langer pour Konver 70x140 et commode
Wickelaufgabe für Konver 70x140 und Kommode
Fasciatoio Konver 70x140 e cassettiera



633-114*

10 x 51 x 82 cm

Bath changer cover without foam
Funda vestidor sin espuma para bañeras
Housse supplémentaire sans mousse pour baignoires
Bezug für Wickelaufgabe ohne Schaumstoff für Waschtisch
Fodera fasciatoio (senza materassino) per bagnetti



634-114

8 x 46 x 65 cm

Top changer for Konver 60x120
Vestidor para Konver 60x120
Matelas à langer pour Konver 60x120
Wickelaufgabe für Konver 60x120
Fasciatoio Konver 60x120



* Inside foam ref. R-VE1 not included | Espuma interior Ref. R-VE1, no incluida
Mousse intérieure Réf. R-VE1 pas incluse | Wickelaufgabe Ref. R-VE1 nicht inklusive | Materassino Rif. R-VE1, non incluso

GALAXY 114



60x120

606-114

92 x 140 cm

Duvet cover (with duvet)
Nórdico (con relleno)
 Housse et couette
Bettbezug (mit Decke)
 Piumino nordico (con imbottitura)

70x140

626-114

105 x 165 cm

90x200

636-114

155 x 250 cm



60x120

606F-114

92 x 140 cm

Duvet cover (without duvet)
Funda nórdica (sin relleno)
 Housse pour couette
Bettbezug (ohne Decke)
 Sacco nordico (senza imbottitura)

70x140

626F-114

105 x 165 cm

90x200

636F-114

155 x 250 cm

60x120

607-114

180 x 44 cm

Bumper Protector
 Tour de lit
Nestchen
 Paracolpi

70x140

627-114

210 x 44 cm



619-114

41 x 34 x 34 cm

Padded fabric storage basket
Saco de juguetes textil acolchado
 Panier de rangement matelassé
Gefütterter Korb für Spielwaren
 Sacco portagiocchi trapuntato



60x120

612-114

110 x 150 cm

Cot sheets set - 3 pieces (100% Cotton)
Sábanas cuna - 3 piezas (100% Algodón)
 Parure de lit - 3 pièces (100% Coton)
Bettwäsche - 3 tlg. (100% Baumwolle)
 Lenzuola lettino - 3 pezzi (100% Cotone)

70x140

632-114

135 x 175 cm

616-114

95 x 122 cm

Crib sheets set - 3 pieces (100% Cotton)
Sábanas minicuna - 3 piezas (100% Algodón)
 Parure de berceau - 3 pièces (100% Coton)
Bettwäsche für Wiege 3-tlg. (100% Baumwolle)
 Lenzuola culla - 3 pezzi (100% Cotone)



698-114

8 x 29 x 26 cm
 8 x 42 x 26 cm



Sleep positioner with removable cover
Cojín Antivelco bebé desenfundable
 Cale-bébé déhoussable
Seitenschläferkissen (abziehbar)
 Riduttore dormisicuro sfoderabile



618-114

21 x 30 x 20 cm

Padded baby toiletries basket
Cesta colonias infantil acolchada
 Panier matelassé pour produits de soin
Gefütterter Stoffkorb für Badeartikel
 Cestino portasaponi trapuntato



689-153

36 x 43 x 12 cm

Kids cushion · Mountains
Cojín infantil · Montañas
Coussin enfant · Montagnes
Kinder-Kissen · Berge
Cuscino decorativo · Montagna



691-153

36 x 32 x 10 cm

Kids cushion · Teepee tent
Cojín infantil · Tipi
Coussin enfant · Tipi
Kinder-Kissen · Tipi
Cuscino decorativo · Tenda



692L-900

35 x 43 x 11 cm

Kids cushion · Triangle
Cojín infantil · Triángulo
Coussin enfant · Triangle
Kinder-Kissen · Dreieck
Cuscino decorativo · Triangolo



692G-153

35 x 43 x 11 cm

Kids cushion · Triangle
Cojín infantil · Triángulo
Coussin enfant · Triangle
Kinder-Kissen · Dreieck
Cuscino decorativo · Triangolo



694-153

▼ 18 x 12 cm

Garland-pennants (2,50 m long)
Guirnalda-banderines infantiles (2,50 m largo)
Guirlande-banderole (2,50 m longueur)
Stoff-Girlande (2,50 m lang)
Ghirlanda-bandierine (2,50 m. lunghezza)

▼
x16



693-153

☆ 34 x 34 x 10 cm ♥ 20 x 20 x 8 cm ☾ 26 x 20 x 8 cm

Set 3 decorative cushions
Set 3 cojines infantiles decoración
Set 3 coussins décoratifs
Set 3 Dekokissen
Set 3 cuscini da decorazione

Set
3
pieces



618-153

21 x 30 x 20 cm

Padded baby toiletries basket
Cesta colonias infantil acolchada
Panier matelassé pour produits de soin
Gefütterter Stoffkorb für Badeartikel
Cestino portasaponi trapuntato



690G-153

35 x 35 x 15 cm

Square cushion with removable cover
Cojín infantil cuadrado desfundable
Coussin carré déhoussable
Quadratisches Kissen (abziehbar)
Cuscino quadrato sfoderabile

▼



631-153

15 x 60 x 90 cm

Top changer for Konver 70x140 and chest
Vestidor para Konver 70x140 y cómoda
Matelas à langer pour Konver 70x140 et commode
Wickelaufgabe für Konver 70x140 und Kommode
Fasciatoio Konver 70x140 e cassetiera

▼
VELCRO



633-153*

10 x 51 x 82 cm

Bath changer cover without foam
Funda vestidor sin espuma para bañeras
Housse supplémentaire sans mousse pour baignoires
Bezug für Wickelaufgabe ohne Schaumstoff für Waschtisch
Fodera fasciatoio (senza materassino) per bagnetti

▼



634-153

8 x 46 x 65 cm

Top changer for Konver 60x120
Vestidor para Konver 60x120
Matelas à langer pour Konver 60x120
Wickelaufgabe für Konver 60x120
Fasciatoio Konver 60x120

▼



619-153

41 x 34 x 34 cm

Padded fabric storage basket
Saco de juguetes textil acolchado
Panier de rangement matelassé
Gefütterter Korb für Spielwaren
Sacco portagiochi trapuntato



* Inside foam ref. R-VE1 not included | Espuma interior Ref. R-VE1, no incluida
Mousse intérieure Réf. R-VE1 pas incluse | Wickelaufgabe Ref. R-VE1 nicht inklusive | Materassino Rif. R-VE1, non incluso

ARENA 153



60x120

606-153

92 x 140 cm

70x140

626-153

105 x 165 cm

90x200

636-153

155 x 250 cm

Duvet cover (with duvet)
Nórdico (con relleno)
 Housse et couette
 Bettbezug (mit Decke)
 Piumino nordico (con imbottitura)

60x120

606F-153

92 x 140 cm

70x140

626F-153

105 x 165 cm

90x200

636F-153

155 x 250 cm

Duvet cover (without duvet)
Funda nórdica (sin relleno)
 Housse pour couette
 Bettbezug (ohne Decke)
 Sacco nordico (senza imbottitura)



Co-sleeping crib & textile set (+ info pages 6-7)
Minicuna de colecho y Kit textil (+ info págs. 6-7)
 Berceau cododo + kit textile (+ info pages 6-7)
 Beistellbett + Textil-Set (+ Info auf Seiten 6-7)
 Culla fianco letto + pack tessile (+ info pages 6-7)

60x120

607-153

180 x 44 cm

70x140

627-153

210 x 44 cm

Bumper Protector
 Tour de lit
 Nestchen
 Paracolpi



646-153

132 x 115 x 115 cm

Kids tepee tent
Tipi infantil
 Tipi enfant
 Tipi- Kinderzelt
 Tenda indiana



60x120

612-153

110 x 150 cm

70x140

632-153

135 x 175 cm

Cot sheets set - 3 pieces (100% Cotton)
Sábanas cuna - 3 piezas (100% Algodón)
 Parure de lit - 3 pièces (100% Coton)
 Bettwäsche - 3 tlg. (100% Baumwolle)
 Lenzuola lettino - 3 pezzi (100% Cotone)

616-153

95 x 122 cm

Crib sheets set - 3 pieces (100% Cotton)
Sábanas minicuna - 3 piezas (100% Algodón)
 Parure de berceau - 3 pièces (100% Coton)
 Bettwäsche für Wiege 3-tlg. (100% Baumwolle)
 Lenzuola culla - 3 pezzi (100% Cotone)



698-153

8 x 29 x 26 cm
 8 x 42 x 26 cm



Sleep positioner with removable cover
Cojín Antivelco bebé desenfundable
 Cale-bébé déhoussable
 Seitenschläferkissen (abziehbar)
 Riduttore dormisicuro sfoderabile



647-153

115 x 115 cm

Carpet for tepee tent
Alfombra para Tipi infantil
 Tapis pour tipi
 Teppich für Tipi- Kinderzelt
 Tappeto per tenda indiana



Set
 3
 pieces

689-178

36 x 43 x 12 cm

Kids cushion · Mountains
Cojin infantil · Montañas
Coussin enfant · Montagnes
Kinder-Kissen · Berge
Cuscino decorativo · Montagna



691-178

36 x 32 x 10 cm

Kids cushion · Teepee tent
Cojin infantil · Tipi
Coussin enfant · Tipi
Kinder-Kissen · Tipi
Cuscino decorativo · Tenda



692L-900

35 x 43 x 11 cm

Kids cushion · Triangle
Cojin infantil · Triángulo
Coussin enfant · Triangle
Kinder-Kissen · Dreieck
Cuscino decorativo · Triangolo



692G-178

35 x 43 x 11 cm

Kids cushion · Triangle
Cojin infantil · Triángulo
Coussin enfant · Triangle
Kinder-Kissen · Dreieck
Cuscino decorativo · Triangolo



694-178

▼ 18 x 12 cm

Garland-pennants (2,50 m long)
Guiraldas-banderines infantiles (2,50 m largo)
Guirlande-banderole (2,50 m longueur)
Stoff-Girlande (2,50 m lang)
Ghirlanda-bandierine (2,50 m. lunghezza)



693-178

☆ 34 x 34 x 10 cm ♥ 20 x 20 x 8 cm ☾ 26 x 20 x 8 cm

Set 3 decorative cushions
Set 3 cojines infantiles decoración
Set 3 coussins décoratifs
Set 3 Dekokissen
Set 3 cuscini da decorazione



618-178

21 x 30 x 20 cm

Padded baby toiletries basket
Cesta colonias infantil acolchada
Panier matelassé pour produits de soin
Gefütterter Stoffkorb für Badeartikel
Cestino portasaponi trapuntato



690G-178

35 x 35 x 15 cm

Square cushion with removable cover
Cojin infantil cuadrado desfundable
Coussin carré déhoussable
Quadratisches Kissen (abziehbar)
Cuscino quadrato sfoderabile



631-178

15 x 60 x 90 cm

Top changer for Konver 70x140 and chest
Vestidor para Konver 70x140 y cómoda
Matelas à langer pour Konver 70x140 et commode
Wickelauflage für Konver 70x140 und Kommode
Fasciatoio Konver 70x140 e cassettiera



633-178*

10 x 51 x 82 cm

Bath changer cover without foam
Funda vestidor sin espuma para bañeras
Housse supplémentaire sans mousse pour baignoires
Bezug für Wickelaufgabe ohne Schaumstoff für Waschtisch
Fodera fasciatoio (senze materassino) per bagnetti



634-178

8 x 46 x 65 cm

Top changer for Konver 60x120
Vestidor para Konver 60x120
Matelas à langer pour Konver 60x120
Wickelaufgabe für Konver 60x120
Fasciatoio Konver 60x120



619-178

41 x 34 x 34 cm

Padded fabric storage basket
Saco de juguetes textil acolchado
Panier de rangement matelassé
Gefütterter Korb für Spielwaren
Sacco portagiochi trapuntato



* Inside foam ref. R-VE1 not included | Espuma interior Ref. R-VE1, no incluida
Mousse intérieure Réf. R-VE1 pas incluse | Wickelaufgabe Ref. R-VE1 nicht inklusive | Materassino Rif. R-VE1, non incluso

CAREZZA 178



606-178 60x120
92 x 140 cm

626-178 70x140
105 x 165 cm

636-178 90x200
155 x 250 cm

Duvet cover (with duvet)
Nórdico (con relleno)
Housse et couette
Bettbezug (mit Decke)
Piumino nordico (con imbottitura)

606F-178 60x120
92 x 140 cm

626F-178 70x140
105 x 165 cm

636F-178 90x200
155 x 250 cm

Duvet cover (without duvet)
Funda nórdica (sin relleno)
Housse pour couette
Bettbezug (ohne Decke)
Sacco nordico (senza imbottitura)



Co-sleeping crib & textile set (+ info pages 6-7)
Minicuna de colecho y Kit textil (+ info págs. 6-7)
Berceau cododo + kit textile (+ info pages 6-7)
Beistellbett + Textil-Set (+ Info auf Seiten 6-7)
Culla fianco letto + pack tessile (+ info pages 6-7)

607-178 60x120
180 x 44 cm

627-178 70x140
210 x 44 cm

Bumper Protector
Tour de lit
Nestchen
Paracolpi



646-178
132 x 115 x 115 cm

Kids tepee tent
Tipi infantil
Tipi enfant
Tipi- Kinderzelt
Tenda indiana



612-178 60x120
110 x 150 cm

632-178 70x140
135 x 175 cm

Cot sheets set - 3 pieces (100% Cotton)
Sábanas cuna - 3 piezas (100% Algodón)
Parure de lit - 3 pièces (100% Coton)
Bettwäsche - 3 tlg. (100% Baumwolle)
Lenzuola lettino - 3 pezzi (100% Cotone)

616-178
95 x 122 cm

Crib sheets set - 3 pieces (100% Cotton)
Sábanas minicuna - 3 piezas (100% Algodón)
Parure de berceau - 3 pièces (100% Coton)
Bettwäsche für Wiege 3-tlg. (100% Baumwolle)
Lenzuola culla - 3 pezzi (100% Cotone)



698-178

8 x 29 x 26 cm
8 x 42 x 26 cm

Sleep positioner with removable cover
Cojín Antivelco bebé desfundable
Cale-bébé déhoussable
Seitenschläferkissen (abziehbar)
Riduttore dormisicuro sfoderabile



647-178
115 x 115 cm

Carpet for tepee tent
Alfombra para Tipi infantil
Tapis pour tipi
Teppich für Tipi- Kinderzelt
Tappeto per tenda indiana



Set
3
pieces

690E-179

35 x 35 x 15 cm

Square cushion with removable cover
Cojín infantil cuadrado desenfundable
 Coussin carré déhoussable
Quadratisches Kissen (abziehbar)
 Cuscino quadrato sfoderabile

**690L-179**

35 x 35 x 15 cm

Square cushion with removable cover
Cojín infantil cuadrado desenfundable
 Coussin carré déhoussable
Quadratisches Kissen (abziehbar)
 Cuscino quadrato sfoderabile

**618-179**

21 x 30 x 20 cm

Padded baby toiletries basket
Cesta colonias infantil acolchada
 Panier matelassé pour produits de soin
Gefütterter Stoffkorb für Badeartikel
 Cestino portasaponi trapuntato

**694-179**

▼ 18 x 12 cm

Garland-pennants (2,50 m long)
Guiraldas-banderines infantiles (2,50 m largo)
 Guirlande-banderole (2,50 m longueur)
Stoff-Girlande (2,50 m lang)
 Ghirlanda-bandierine (2,50 m. lunghezza)

**693-179**

☆ 34 x 34 x 10 cm ♥ 20 x 20 x 8 cm ☾ 26 x 20 x 8 cm

Set 3 decorative cushions
Set 3 cojines infantiles decoración
 Set 3 coussins décoratifs
Set 3 Dekokissen
 Set 3 cuscini da decorazione

**619-179**

41 x 34 x 34 cm

Padded fabric storage basket
Saco de juguetes textil acolchado
 Panier de rangement matelassé
Gefütterter Korb für Spielwaren
 Sacco portagiocchi trapuntato

**631-179**

15 x 60 x 90 cm

Top changer for Konver 70x140 and chest
Vestidor para Konver 70x140 y cómoda
 Matelas à langer pour Konver 70x140 et commode
Wickelaufgabe für Konver 70x140 und Kommode
 Fasciatoio Konver 70x140 e cassetiera

**633-179***

10 x 51 x 82 cm

Bath changer cover without foam
Funda vestidor sin espuma para bañeras
 Housse supplémentaire sans mousse pour baignoires
Bezug für Wickelaufgabe ohne Schaumstoff für Waschtisch
 Fodera fasciatoio (senza materassino) per bagnetti

**634-179**

8 x 46 x 65 cm

Top changer for Konver 60x120
Vestidor para Konver 60x120
 Matelas à langer pour Konver 60x120
Wickelaufgabe für Konver 60x120
 Fasciatoio Konver 60x120



* Inside foam ref. R-VE1 not included | Espuma interior Ref. R-VE1, no incluida
 Mousse intérieure Réf. R-VE1 pas incluse | Wickelaufgabe Ref. R-VE1 nicht inklusive | Materassino Rif. R-VE1, non incluso



60x120

606-179

92 x 140 cm

Duvet cover (with duvet)
Nórdico (con relleno)
 Housse et couette
 Bettbezug (mit Decke)
 Piumino nordico (con imbottitura)

70x140

626-179

105 x 165 cm

90x200

636-179

155 x 250 cm

60x120

606F-179

92 x 140 cm

Duvet cover (without duvet)
Funda nórdica (sin relleno)
 Housse pour couette
 Bettbezug (ohne Decke)
 Sacco nordico (senza imbottitura)

70x140

626F-179

105 x 165 cm

90x200

636F-179

155 x 250 cm



636-179
636F-179

Co-sleeping crib & textile set (+ info pages 6-7)
Minicuna de colecho y Kit textil (+ info págs. 6-7)
 Berceau cododo + kit textile (+ info pages 6-7)
 Beistellbett + Textil-Set (+ Info auf Seiten 6-7)
 Culla fianco letto + pack tessile (+ info pages. 6-7)

60x120

607-179

180 x 44 cm

Bumper Protector
 Tour de lit
 Nestchen
 Paracolpi



70x140

627-179

210 x 44 cm



646-179

132 x 115 x 115 cm

Kids tepee tent
 Tipi infantil
 Tipi enfant
 Tipi- Kinderzelt
 Tenda indiana



60x120

612-179

110 x 150 cm

Cot sheets set - 3 pieces (100% Cotton)
Sábanas cuna - 3 piezas (100% Algodón)
 Parure de lit - 3 pièces (100% Coton)
 Bettwäsche - 3 tlg. (100% Baumwolle)
 Lenzuola lettino - 3 pezzi (100% Cotone)

70x140

632-179

135 x 175 cm

616-179

95 x 122 cm

Crib sheets set - 3 pieces (100% Cotton)
Sábanas minicuna - 3 piezas (100% Algodón)
 Parure de berceau - 3 pièces (100% Coton)
 Bettwäsche für Wiege 3-tlg. (100% Baumwolle)
 Lenzuola culla - 3 pezzi (100% Cotone)



698-179

8 x 29 x 26 cm

8 x 42 x 26 cm

Sleep positioner with removable cover
Cojín Antivelco bebé desfundable
 Cale-bébé déhoussable
 Seitenschläferkissen (abziehbar)
 Riduttore dormisicuro sfoderabile



647-179

115 x 115 cm

Carpet for tepee tent
Alfombra para Tipi infantil
 Tapis pour tipi
 Teppich für Tipi- Kinderzelt
 Tappeto per tenda indiana



Set
3
 pieces

690E-181

35 x 35 x 15 cm

Square cushion with removable cover
Cojín infantil cuadrado desenfundable
 Coussin carré déhoussable
 Quadratisches Kissen (abziehbar)
 Cuscino quadrato sfoderabile

**690L-181**

35 x 35 x 15 cm

Square cushion with removable cover
Cojín infantil cuadrado desenfundable
 Coussin carré déhoussable
 Quadratisches Kissen (abziehbar)
 Cuscino quadrato sfoderabile

**618-181**

21 x 30 x 20 cm

Padded baby toiletries basket
Cesta colonias infantil acolchada
 Panier matelassé pour produits de soin
 Gefütterter Stoffkorb für Badeartikel
 Cestino portasaponi trapuntato

**694-181**

▼ 18 x 12 cm

Garland-pennants (2,50 m long)
Guiraldas-banderines infantiles (2,50 m largo)
 Guirlande-banderole (2,50 m longueur)
 Stoff-Girlande (2,50 m lang)
 Ghirlanda-bandierine (2,50 m. lunghezza)

**693-181**

☆ 34 x 34 x 10 cm ♥ 20 x 20 x 8 cm ☾ 26 x 20 x 8 cm

Set 3 decorative cushions
Set 3 cojines infantiles decoración
 Set 3 coussins décoratifs
 Set 3 Dekokissen
 Set 3 cuscini da decorazione

**619-181**

41 x 34 x 34 cm

Padded fabric storage basket
Saco de juguetes textil acolchado
 Panier de rangement matelassé
 Gefütterter Korb für Spielwaren
 Sacco portagiocchi trapuntato

**631-181**

15 x 60 x 90 cm

Top changer for Konver 70x140 and chest
Vestidor para Konver 70x140 y cómoda
 Matelas à langer pour Konver 70x140 et commode
 Wickelaufgabe für Konver 70x140 und Kommode
 Fasciatoio Konver 70x140 e cassetiera

**633-181***

10 x 51 x 82 cm

Bath changer cover without foam
Funda vestidor sin espuma para bañeras
 Housse supplémentaire sans mousse pour baignoires
 Bezug für Wickelaufgabe ohne Schaumstoff für Waschtisch
 Fodera fasciatoio (senza materassino) per bagnetti

**634-181**

8 x 46 x 65 cm

Top changer for Konver 60x120
Vestidor para Konver 60x120
 Matelas à langer pour Konver 60x120
 Wickelaufgabe für Konver 60x120
 Fasciatoio Konver 60x120



* Inside foam ref. R-VE1 not included | Espuma interior Ref. R-VE1, no incluida
 Mousse intérieure Réf. R-VE1 pas incluse | Wickelaufgabe Ref. R-VE1 nicht inklusive | Materassino Rif. R-VE1, non incluso

MARE 181



606-181 92 x 140 cm
626-181 105 x 165 cm
636-181 155 x 250 cm

Duvet cover (with duvet)
Nórdico (con relleno)
 Housse et couette
Bettbezug (mit Decke)
 Piumino nordico (con imbottitura)

606F-181 92 x 140 cm
626F-181 105 x 165 cm
636F-181 155 x 250 cm

Duvet cover (without duvet)
Funda nórdica (sin relleno)
 Housse pour couette
Bettbezug (ohne Decke)
 Sacco nordico (senza imbottitura)



636-181
636F-181

Co-sleeping crib & textile set (+ info pages 6-7)
Minicuna de colecho y Kit textil (+ info págs. 6-7)
 Berceau cododo + kit textile (+ info pages 6-7)
Beistellbett + Textil-Set (+ Info auf Seiten 6-7)
 Culla fianco letto + pack tessile (+ info pags. 6-7)

607-181 180 x 44 cm
627-181 210 x 44 cm

Bumper Protector
 Tour de lit
Nestchen
 Paracolpi



646-181
 132 x 115 x 115 cm
Kids tepee tent
Tipi infantil
 Tipi enfant
 Tipi- Kinderzelt
 Tenda indiana



612-181 110 x 150 cm
632-181 135 x 175 cm

Cot sheets set - 3 pieces (100% Cotton)
Sábanas cuna - 3 piezas (100% Algodón)
 Parure de lit - 3 pièces (100% Coton)
Bettwäsche - 3 tlg. (100% Baumwolle)
 Lenzuola lettino - 3 pezzi (100% Cotone)

616-181
 95 x 122 cm

Crib sheets set - 3 pieces (100% Cotton)
Sábanas minicuna - 3 piezas (100% Algodón)
 Parure de berceau - 3 pièces (100% Coton)
Bettwäsche für Wiege 3-tlg. (100% Baumwolle)
 Lenzuola culla - 3 pezzi (100% Cotone)



698-181
 8 x 29 x 26 cm 8 x 42 x 26 cm
Sleep positioner with removable cover
Cojín Antivelco bebé desfundable
 Cale-bébé déhoussable
Seitenschlāferkissen (abziehbar)
 Riduttore dormisicuro sfoderabile



647-181
 115 x 115 cm
Carpet for tepee tent
Alfombra para Tipi infantil
 Tapis pour tipi
Teppich für Tipi- Kinderzelt
 Tappeto per tenda indiana



Set
3
 pieces

690E-182

35 x 35 x 15 cm

Square cushion with removable cover
Cojín infantil cuadrado desfundable
 Coussin carré déhoussable
 Quadratisches Kissen (abziehbar)
 Cuscino quadrato sfoderabile

**690L-182**

35 x 35 x 15 cm

Square cushion with removable cover
Cojín infantil cuadrado desfundable
 Coussin carré déhoussable
 Quadratisches Kissen (abziehbar)
 Cuscino quadrato sfoderabile

**618-182**

21 x 30 x 20 cm

Padded baby toiletries basket
Cesta colonias infantil acolchada
 Panier matelassé pour produits de soin
 Gefütterter Stoffkorb für Badeartikel
 Cestino portasaponi trapuntato

**694-182**

▼ 18 x 12 cm

Garland-pennants (2,50 m long)
Guiraldas-banderines infantiles (2,50 m largo)
 Guirlande-banderole (2,50 m longueur)
 Stoff-Girlande (2,50 m lang)
 Ghirlanda-bandierine (2,50 m. lunghezza)

**693-182**

☆ 34 x 34 x 10 cm ♥ 20 x 20 x 8 cm ☾ 26 x 20 x 8 cm

Set 3 decorative cushions
Set 3 cojines infantiles decoración
 Set 3 coussins décoratifs
 Set 3 Dekokissen
 Set 3 cuscini da decorazione

**619-182**

41 x 34 x 34 cm

Padded fabric storage basket
Saco de juguetes textil acolchado
 Panier de rangement matelassé
 Gefütterter Korb für Spielwaren
 Sacco portagiochi trapuntato

**631-182**

15 x 60 x 90 cm

Top changer for Konver 70x140 and chest
Vestidor para Konver 70x140 y cómoda
 Matelas à langer pour Konver 70x140 et commode
 Wickelaufgabe für Konver 70x140 und Kommode
 Fasciatoio Konver 70x140 e cassetiera

**633-182***

10 x 51 x 82 cm

Bath changer cover without foam
Funda vestidor sin espuma para bañeras
 Housse supplémentaire sans mousse pour baignoires
 Bezug für Wickelaufgabe ohne Schaumstoff für Waschtisch
 Fodera fasciatoio (senza materassino) per bagnetti

**634-182**

8 x 46 x 65 cm

Top changer for Konver 60x120
Vestidor para Konver 60x120
 Matelas à langer pour Konver 60x120
 Wickelaufgabe für Konver 60x120
 Fasciatoio Konver 60x120



* Inside foam ref. R-VE1 not included | Espuma interior Ref. R-VE1, no incluida
 Mousse intérieure Réf. R-VE1 pas incluse | Wickelaufgabe Ref. R-VE1 nicht inklusive | Materassino Rif. R-VE1, non incluso

ROSE 182



60x120

606-182

92 x 140 cm

70x140

626-182

105 x 165 cm

90x200

636-182

155 x 250 cm

Duvet cover (with duvet)
Nórdico (con relleno)
 Housse et couette
Bettbezug (mit Decke)
 Piumino nordico (con imbottitura)

60x120

606F-182

92 x 140 cm

70x140

626F-182

105 x 165 cm

90x200

636F-182

155 x 250 cm

Duvet cover (without duvet)
Funda nórdica (sin relleno)
 Housse pour couette
Bettbezug (ohne Decke)
 Sacco nordico (senza imbottitura)



636-182
636F-182

60x120

607-182

180 x 44 cm

70x140

627-182

210 x 44 cm

Bumper Protector
 Tour de lit
Nestchen
 Paracolpi



646-182

132 x 115 x 115 cm

Kids tepee tent
Tipi infantil
 Tipi enfant
 Tipi- Kinderzelt
 Tenda indiana



60x120

612-182

110 x 150 cm

70x140

632-182

135 x 175 cm

Cot sheets set - 3 pieces (100% Cotton)
Sábanas cuna - 3 piezas (100% Algodón)
 Parure de lit - 3 pièces (100% Coton)
Bettwäsche - 3 tlg. (100% Baumwolle)
 Lenzuola lettino - 3 pezzi (100% Cotone)

616-182

95 x 122 cm

Crib sheets set - 3 pieces (100% Cotton)
Sábanas minicuna - 3 piezas (100% Algodón)
 Parure de berceau - 3 pièces (100% Coton)
Bettwäsche für Wiege 3-tlg. (100% Baumwolle)
 Lenzuola culla - 3 pezzi (100% Cotone)



698-182

8 x 29 x 26 cm

8 x 42 x 26 cm

Sleep positioner with removable cover
Cojín Antivelco bebé desenfundable
 Cale-bébé déhoussable
Seitenschlâferkissen (abziehbar)
 Riduttore dormisicuro sfoderabile



647-182

115 x 115 cm

Carpet for tepee tent
Alfombra para Tipi infantil
 Tapis pour tipi
Teppich für Tipi- Kinderzelt
 Tappeto per tenda indiana



Set
3
 pieces

689-194

36 x 43 x 12 cm

Kids cushion · Mountains
Cojin infantil · Montañas
Coussin enfant · Montagnes
Kinder-Kissen · Berge
Cuscino decorativo · Montagna



691-194

36 x 32 x 10 cm

Kids cushion · Teepee tent
Cojin infantil · Tipi
Coussin enfant · Tipi
Kinder-Kissen · Tipi
Cuscino decorativo · Tenda



690E-194

35 x 35 x 15 cm

Square cushion with removable cover
Cojin infantil cuadrado desenfundable
Coussin carré déhoussable
Quadratisches Kissen (abziehbar)
Cuscino quadrato sfoderabile



694-194

▼ 18 x 12 cm

Garland-pennants (2,50 m long)
Guiraldas-banderines infantiles (2,50 m largo)
Guirlande-banderole (2,50 m longueur)
Stoff-Girlande (2,50 m lang)
Ghirlanda-bandierine (2,50 m. lunghezza)



693-194

☆ 34 x 34 x 10 cm ♥ 20 x 20 x 8 cm ☾ 26 x 20 x 8 cm

Set 3 decorative cushions
Set 3 cojines infantiles decoración
Set 3 coussins décoratifs
Set 3 Dekokissen
Set 3 cuscini da decorazione



618-194

21 x 30 x 20 cm

Padded baby toiletries basket
Cesta colonias infantil acolchada
Panier matelassé pour produits de soin
Gefütterter Stoffkorb für Badeartikel
Cestino portasaponi trapuntato



631-194

15 x 60 x 90 cm

Top changer for Konver 70x140 and chest
Vestidor para Konver 70x140 y cómoda
Matelas à langer pour Konver 70x140 et commode
Wickelaufgabe für Konver 70x140 und Kommode
Fasciatoio Konver 70x140 e cassetiera



633-194*

10 x 51 x 82 cm

Bath changer cover without foam
Funda vestidor sin espuma para bañeras
Housse supplémentaire sans mousse pour baignoires
Bezug für Wickelaufgabe ohne Schaumstoff für Waschtisch
Fodera fasciatoio (senza materassino) per bagnetti



634-194

8 x 46 x 65 cm

Top changer for Konver 60x120
Vestidor para Konver 60x120
Matelas à langer pour Konver 60x120
Wickelaufgabe für Konver 60x120
Fasciatoio Konver 60x120



* Inside foam ref. R-VE1 not included | Espuma interior Ref. R-VE1, no incluida
Mousse intérieure Réf. R-VE1 pas incluse | Wickelaufgabe Ref. R-VE1 nicht inklusive | Materassino Rif. R-VE1, non incluso

VENTO 194



60x120

606-194

92 x 140 cm

Duvet cover (with duvet)
Nórdico (con relleno)
Housse et couette
Bettbezug (mit Decke)
Piumino nordico (con imbottitura)

70x140

626-194

105 x 165 cm

90x200

636-194

155 x 250 cm

60x120

606F-194

92 x 140 cm

Duvet cover (without duvet)
Funda nórdica (sin relleno)
Housse pour couette
Bettbezug (ohne Decke)
Sacco nordico (senza imbottitura)

70x140

626F-194

105 x 165 cm

90x200

636F-194

155 x 250 cm



Co-sleeping crib & textile set (+ info pages 6-7)
Minicuna de colecho y Kit textil (+ info págs. 6-7)
Berceau cododo + kit textile (+ info pages 6-7)
Beistellbett + Textil-Set (+ Info auf Seiten 6-7)
Culla fianco letto + pack tessile (+ info pages. 6-7)

60x120

607-194

180 x 44 cm

Bumper Protector
Tour de lit
Nestchen
Paracolpi

70x140

627-194

210 x 44 cm



619-194

41 x 34 x 34 cm

Padded fabric storage basket
Saco de juguetes textil acolchado
Panier de rangement matelassé
Gefütterter Korb für Spielwaren
Sacco portagiochi trapuntato



60x120

612-194

110 x 150 cm

Cot sheets set - 3 pieces (100% Cotton)
Sábanas cuna - 3 piezas (100% Algodón)
Parure de lit - 3 pièces (100% Coton)
Bettwäsche - 3 tlg. (100% Baumwolle)
Lenzuola lettino - 3 pezzi (100% Cotone)

70x140

632-194

135 x 175 cm



616-194

95 x 122 cm

Crib sheets set - 3 pieces (100% Cotton)
Sábanas minicuna - 3 piezas (100% Algodón)
Parure de berceau - 3 pièces (100% Coton)
Bettwäsche für Wiege 3-tlg. (100% Baumwolle)
Lenzuola culla - 3 pezzi (100% Cotone)



698-194

8 x 29 x 26 cm
8 x 42 x 26 cm

Sleep positioner with removable cover
Cojín Antivuelco bebé desenfundable
Cale-bébé déhoussable
Seitenschläferkissen (abziehbar)
Riduttore dormisicuro sfoderabile



MATRESSES & DECO

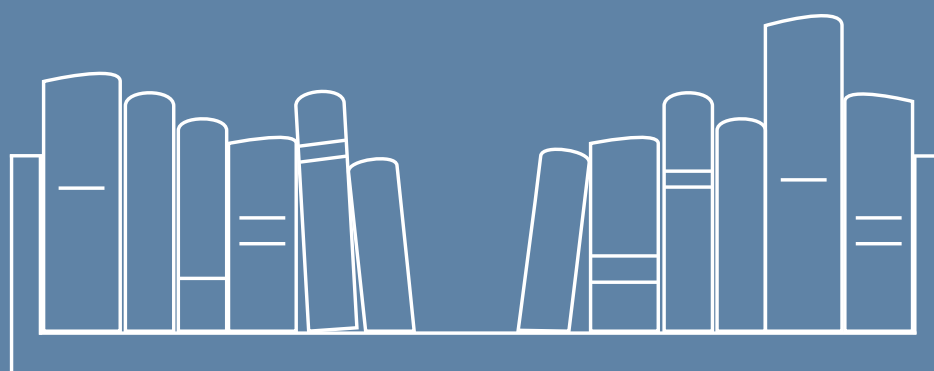

MATRESSES & DECO | COLCHONES Y DECORACIÓN | MATELAS ET DÉCORATION | *MATRATZEN
UND DEKORATION* | MATERASSI E DECORAZIONI

ORGANIC SOJA

MATTRESSES | COLCHONES | MATELAS | MATRATZE | MATERASSI

Organic mattress for babies made with soybean oil.

Organic cotton fabric. Certified "Organic Cotton", which attests that the mattress on which the baby lies has been manufactured with cotton grown under organic farming methods, free of pesticides and other harmful substances.

Prevents SIDS. Mattress designed based on recommendations to prevent SIDS.

Bio core. Made from natural soybean oil, more respectful towards the environment.

Breathable to ensure maximum hygiene. Its ventilation channels keep the baby fresh and dry. Easy to clean. Its all-around zipper allows the cover to be removed and washed easily without losing its properties.

Colchón orgánico para bebés elaborado con aceites naturales de soja.

Tejido de algodón orgánico. Certificado "Organic Cotton" que garantiza que el tejido con el que está fabricado el colchón es natural, procedente de cultivo de algodón ecológico, libre de pesticidas y sustancias nocivas para la salud del bebé.

Prevención muerte súbita. Colchón especialmente diseñado para prevenir la muerte súbita del lactante, siguiendo todas las recomendaciones de los expertos.

Núcleo Bio. Fabricado con aceites naturales de soja. Por su composición natural es más respetuoso con el medio ambiente y garantiza una mayor suavidad para el descanso.

Transpirable e higiénico. Los canales de aireación en ambos lados del colchón ofrecen la máxima transpiración y frescura para el descanso del bebé. Desenfundable y de fácil lavado gracias a la cremallera perimetral que incorpora para poder separar cada una de las piezas.

Matelas organique pour bébé fabriqué à partir d'huile de soja naturelle.

Tissu en coton BIO. Certification "Coton Biologique" garantissant que le matelas sur lequel bébé dormira est produit en coton issu de l'agriculture biologique, sans l'utilisation de pesticides ou d'autres substances pernicieuses.

Prévention morte subite du nourrisson. Matelas conçu en suivant les recommandations pour réduire le risque du syndrome de mort subite du nourrisson.

Noyau Bio. Fabriqué à partir d'huile de soja naturelle, plus respectueux de l'environnement.

Transpirable pour une hygiène parfaite. Système de ventilation pour que bébé soit toujours frais et sec. Facile à nettoyer. Sa fermeture éclair tout autour permet de laver la housse séparément tout en conservant ses propriétés.



Organische Matratze für Babys, hergestellt mit Sojaöl.

Stoff aus Bio-Baumwolle. Das Gütesiegel "kbA" garantiert, dass der Stoff aus kontrolliert ökologischem Anbau stammt und frei von jeglichen Pestiziden und Schadstoffen ist.

Vorbeugung des plötzlichen Kindstodes. Matratze entworfen entsprechend Empfehlungen zur Vorbeugung des plötzlichen Kindstodes.

Biokern. Hergestellt mit umweltschonenden Sojaölen.

Atmungsaktiv und hygienisch. Eingebaute Luftkanäle, damit das Baby immer frisch und trocken schläft. Einfache Reinigung. Durch den rundherumgehenden Reissverschluss kann die Hülle einfach abgezogen werden.

Materasso in Bio Soia per bambini prodotto con oli essenziali di soia.

Tessuto in cotone organico. Certificato "Organic Cotton" che permette al bimbo di dormire su un materasso rivestito in morbido cotone naturale derivante da coltivazioni ecologiche, prive di pesticidi e di sostanze nocive.

Prevenzione della morte improvvisa. Materasso progettato secondo le raccomandazioni per prevenire la morte improvvisa del lattante.

Nucleo in Bio Soia. Prodotto con oli essenziali di soia di origine vegetale, rispettando la natura.

Massima traspirabilità ed igiene. I suoi canali di aerazione mantengono il bimbo sempre fresco e asciutto. Lavaggio facile, la sua chiusura lampo perimetrale consente il lavaggio di ogni singolo componente senza che essi perdano le loro proprietà.

Reference
Referencia
Référénc
Referenz
Riferimento

Cot size
Medidas cuna
Mesures du lit bébé
Maße Babybett
Misure lettino

Mattress size
Medidas del colchón
Mesures du matelas
Maße Matratze
Misure materasso

ZR60-120

60x 120 cm

58x 118x 12 cm

ZR70-140

70x 140 cm

68x 138x 12 cm

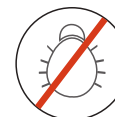
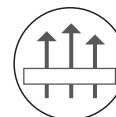

MEMORY VISCO

MATTRESSES | COLCHONES | MATELAS | MATRATZE | MATERASSI

Body-adaptable memory foam mattress.

Body-adaptable.
Memory foam is a material that adapts to the baby's or child's body and relieves any type of pressure on the body during sleep.

Hygiene and comfort.
The mattress composition ensures maximum comfort, breathability and durability. Hypoallergenic and dust mite resistant.

Soft cover.
The mattress cover has a lovely soft feel. Made of OEKO-TEX® Standard 100 stretch fabric.

Removable and washable cover.
Easy-clean. The mattress features a cover that can be easily taken off by undoing the zipper.

Colchón de viscoelástica adaptable, para el correcto descanso del bebé.

Adaptable.
Fabricado con viscoelástica, material que se adapta al cuerpo del bebé o niño evitando cualquier punto de presión durante el descanso.

Higiene y confort.
La composición del colchón asegura la máxima comodidad, transpirabilidad y duración del mismo. Incorpora tratamientos anti ácaros para evitar alergias.

Tejido suave.
El tejido exterior del colchón ofrece una agradable sensación de suavidad. Compuesto por tejido "Stretch" certificado OEKO-TEX® estándar 100.

Desenfundable y lavable.
Colchón higiénico. Fácil de desenfundar gracias a la cremallera perimetral que incorpora.

Matelas en mousse viscoélastique adaptable.

Adaptable.
Fabriqué en mousse à mémoire de forme, qui s'adapte à la morphologie du corps du bébé ou de l'enfant, allégeant ainsi les points de pression pendant le sommeil.

Hygiénique et confortable.
La composition du matelas assure son confort, transpirabilité et durabilité. Traité contre les acariens afin d'éviter des allergies.

Tissu doux.
La housse du matelas offre une sensation douce et moelleuse. Housse en tissu "Stretch" certifié OEKO-TEX® Standard 100.

Matelas déhoussable.
Hygiénique et facile d'entretien. Housse amovible à fermeture éclair et lavable.

Matratze aus Viscoschaum, für den gesunden Schlaf des Kindes.

Anpassung.
Hergestellt aus Viscoschaum. Dieses Material passt sich perfekt an dem Körper des Kindes an, ohne jeglichen Druckpunkte zu verursachen.

Hygiene und Komfort.
Die Zusammensetzung der Matratze garantiert maximalen Komfort, beste Belüftung und eine lange Nutzung. Die Matratze wurde gegen Milben behandelt und ist somit für Allergiker geeignet.

Weicher Stoff.
Der äussere Stoff der Matratze, hergestellt nach OEKO-TEX® Standard 100, ist angenehm weich.

Abzieh- und waschbar.
Der Matratzenbezug ist mit einem Reißverschluss versehen und kann abgezippt werden.

Materasso anatomico viscoelastico, per un sano e corretto riposo del bimbo.

Anatomico.
Prodotto in schiuma viscoelastica, materiale che con il calore prende la forma del corpo del bimbo evitando qualsiasi punto di pressione durante il riposo.

Igiene e confort.
La composizione del materasso garantisce la massima comodità, traspirabilità e durata dello stesso. Il trattamento antiacaro previene eventuali reazioni allergiche.

Morbido tessuto.
Il tessuto esterno del materasso offre una gradevole sensazione di morbidezza. Prodotto in tessuto "Stretch" certificato OEKO-TEX® standard 100.

Sfoderabile e lavabile.
Materasso igienico. Facile da sfoderare grazie alla pratica chiusura zip perimetrale.



Reference Referencia Référence Referenz Riferimento	Bed / cot size Medidas cuna / cama Mesures du lit bébé / junior Maße Baby-/Jugendbett Misure lettino / letto	Mattress size Medidas del colchón Mesures du matelas Maße Matratze Misure materasso
ZC90-200*	90 x 200 cm	90 x 200 x 22 cm
ZC80-200*	80 x 200 cm	80 x 200 x 22 cm
ZN90-190*	90 x 190 cm	90 x 190 x 15 cm
ZV60-120	60 x 120 cm	58 x 118 x 12 cm
ZV70-140	70 x 140 cm	68 x 138 x 12 cm
ZY50-80	50 x 80 cm	53 x 80 x 5 cm

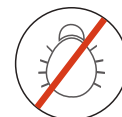
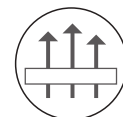
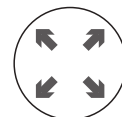

Ref.: ZY50-80



Ref.: ZV60-120 / ZV70-140



Ref.: ZC90-200 / ZC80-200 / ZN90-190
* No es desenfundable

DECO

ACCESSORIES | ACCESORIOS | ACCESSOIRES
ZUBEHÖR | ACCESSORI

H560 Modular shelf (small) | Balda-estante modular (pequeña) Étagère murale modulaire (petite) | Wandregal Modular (klein) | Mensola modulare (piccola)



H560-M5100
Matte



H560-M5200
Matte



H560-M5300
Matte



H560-M5500
Matte



H560-M7700
Matte



H560-M7800
Matte



H560-M7900
Matte



H560-M8100
Matte



H560-M8200
Matte

4 positions | 4 posiciones | 4 positions | 4 Positionen | 4 posizioni

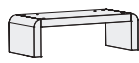
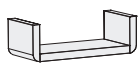

18 x 57,6 x 25 cm

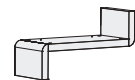
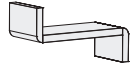

32,2 x 57,6 x 25 cm

H555

Box shelves | Box-pared | Cube
mural | Wandwürfel | Armadietto



H555-M7700
Matte



H555-M7800
Matte

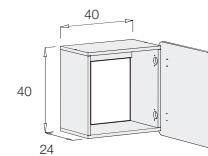

Open | Abierto
Ouvert | Geöffnet
Aperto

H561 Modular shelf (large) | Balda-estante modular (grande) Étagère murale modulaire (grande) | Wandregal Modular (groß) | Mensola modulare (grande)



H561-M5100
Matte



H561-M5200
Matte



H561-M5300
Matte



H561-M5500
Matte



H561-M7700
Matte



H561-M7800
Matte



H561-M7900
Matte



H561-M8100
Matte



H561-M8200
Matte

4 positions | 4 posiciones | 4 positions | 4 Positionen | 4 posizioni



18 x 87,6 x 25 cm

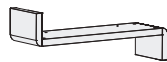

32,2 x 87,6 x 25 cm

R-VE1

Bath changer | Vestidor bañera
Matelas à langer baignoire |
Wickelauflage | Fasciatoio bagnetto

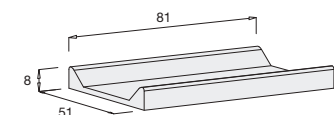

VINYLS

ACCESSORIES | ACCESORIOS | ACCESSOIRES | ZUBEHÖR | ACCESSORI

Y1D / Y2D Hearts vinyl | Vinilo corazones | Sticker coeurs | Aufkleber Herzen | Vinile cuori

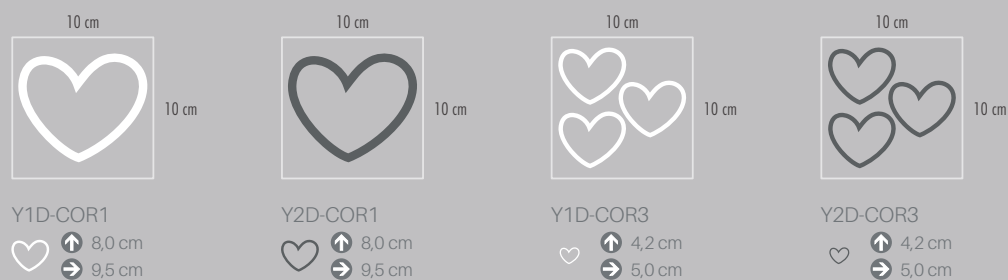

Y1D / Y2D Butterflies vinyl | Vinilo mariposas | Sticker papillons | Aufkleber Schmetterlinge | Vinile Farfalle

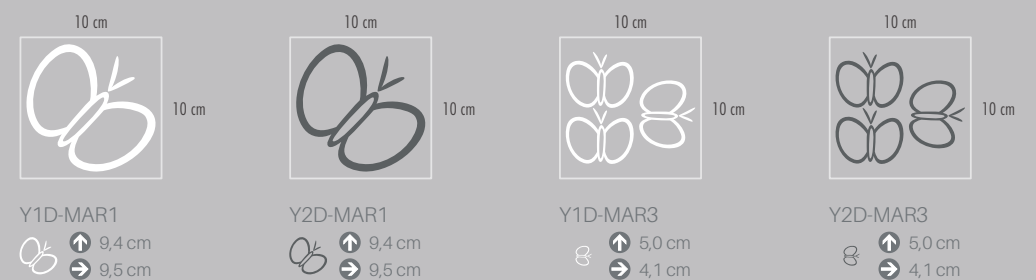

Y1D / Y2D Stars vinyl | Vinilo estrellas | Sticker étoiles | Aufkleber Sterne | Vinile stelle

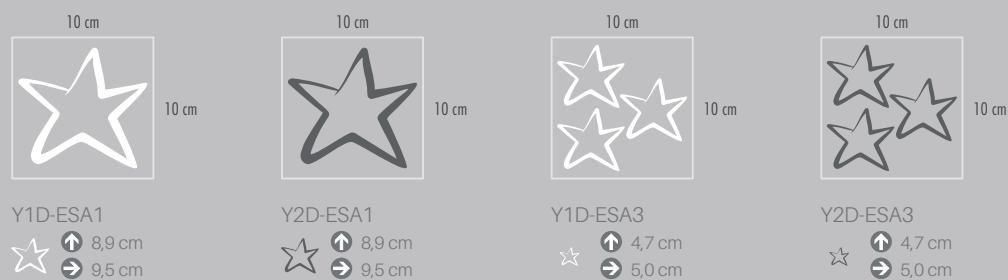

Y1D / Y2D Stars vinyl | Vinilo estrellas | Sticker étoiles | Aufkleber Sterne | Vinile stelle

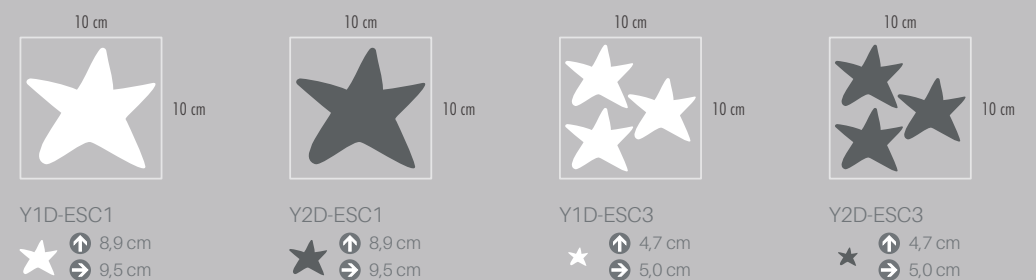

Y1D / Y2D Flowers vinyl | Vinilo flores | Sticker fleurs | Aufkleber Blumen | Vinile fiori

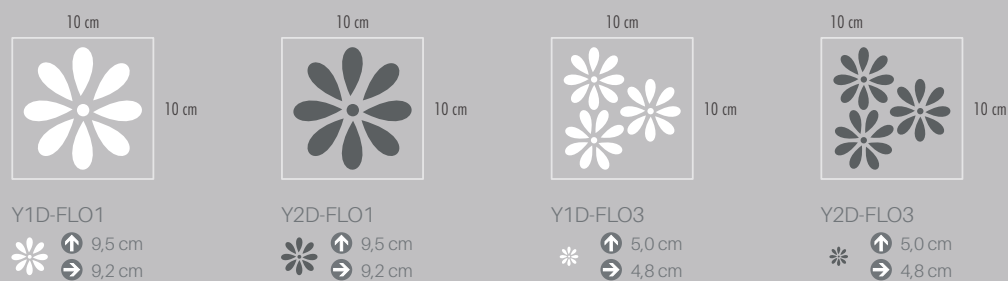

Y1S / Y2S Sun vinyl | Vinilo sol | Sticker soleil | Aufkleber Sonne | Vinile sole



Y1G / Y2G Cloud vinyl | Vinilo nube | Sticker nuage | Aufkleber Wolke | Vinile nuvola

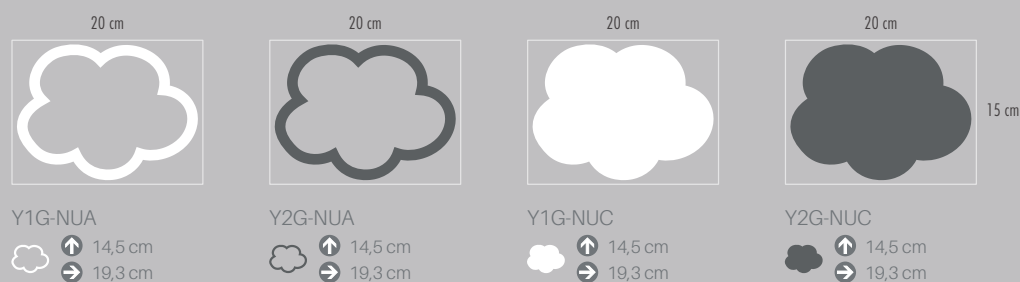

Y1G / Y2G Moon vinyl | Vinilo luna | Sticker lune | Aufkleber Mond | Vinile luna

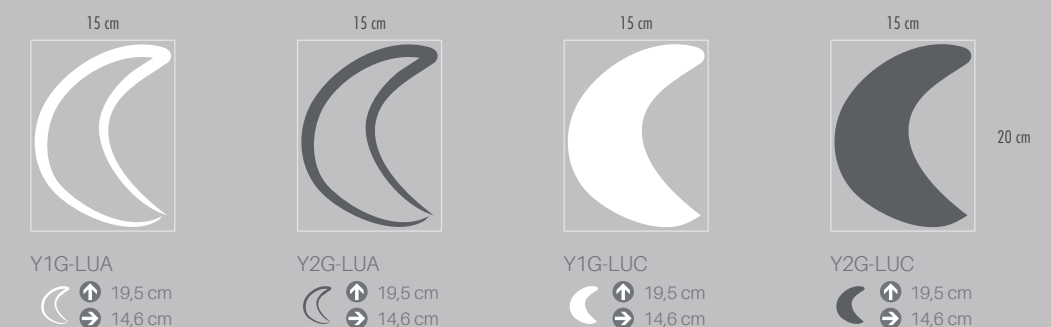

Y1 White vinyl letters | Letras vinilo blanco | Lettres autocollantes blanches | Buchstaben Aufkleber weiss | Lettere vinile bianco



Y2 Gray vinyl letters | Letras vinilo gris | Lettres autocollantes grises | Buchstaben Aufkleber grau | Lettere vinile grigio



COLOURS

TEXTILES | TEXTILES | LAYETTE | TEXTILIEN | TESSILE



T055E-055
280 cm

055 MINT



T055G-055
160 cm



T111E-111
280 cm

111 INDIANA BLU



T901C-901
280 cm



T112E-112
280 cm

112 INDIANA ROSA



T902R-902
280 cm



T114G-114
280 cm

114 GALAXY



T114B-114
280 cm



T153G-153
280 cm

153 ARENA



T900B-900
160 cm



T178G-178
280 cm

178 CAREZZA



T900B-900
160 cm



T179E-179
280 cm

179 ETNIK



179G-179
145 cm



T181T-181
155 cm

181 MARE



T181E-181
280 cm



T182R-182
145 cm

182 ROSE



T182E-182
280 cm



T194E-194
280 cm

194 VENTO



T900B-900
160 cm

Matte | Mate | Mate | Matt | Opaco

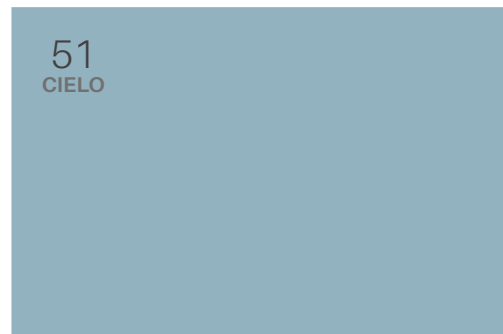

51
CIELO
Blue matte | Celeste mate | Bleu mat
Blau matt | Celeste opaco
NCS S 2020 - R90B



52
CORAL
Pink matte | Rosa mate | Rose mat
Rosa matt | Rosa opaco
NCS S 1020 - R10B

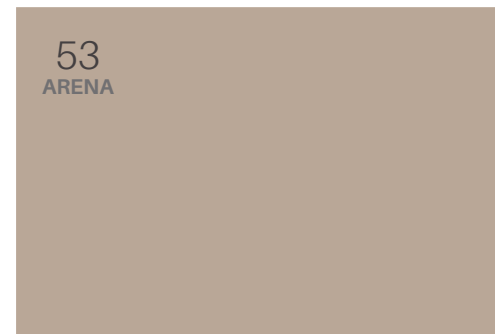

53
ARENA
Beige matte | Beige mate | Beige mat
Beige matt | Beige opaco
NCS S 3005 - Y50R

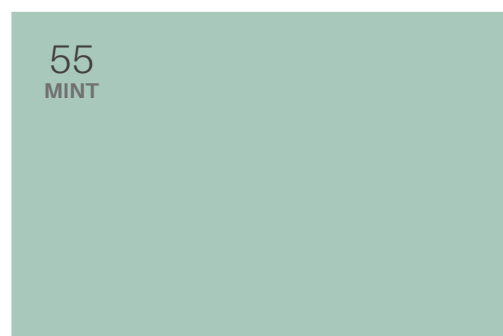

55
MINT
Mint green matte | Verde menta mate | Vert menthe mat
Minzgrün matt | Verde menta opaco
NCS S 2010 - B90G

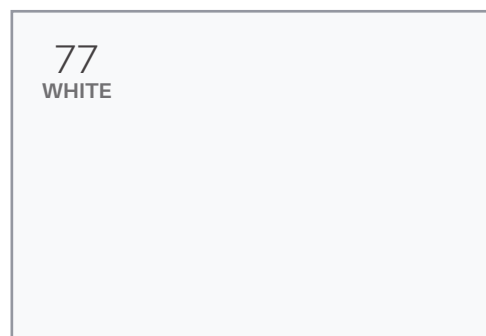

77
WHITE
White matte | Blanco mate | Blanc mat
Weiss matt | Bianco opaco
NCS S 0500 - N

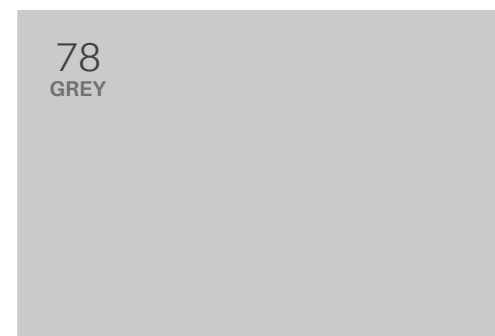

78
GREY
Grey matte | Gris mate | Grise mat
Grau matt | Grigio opaco
NCS S 2500 - N



79
ETNIK
Anthracite matte | Antracita mate | Anthracite mat
Anthrazit matt | Grigio antracite opaco
NCS S 6005 - R80B

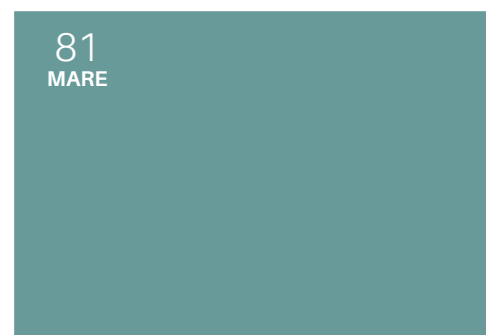

81
MARE
Aquamarine matte | Verde-agua mate | Bleu vert mat
Aquamarinblau matt | Verde acqua opaco
NCS S 3020 - B30G

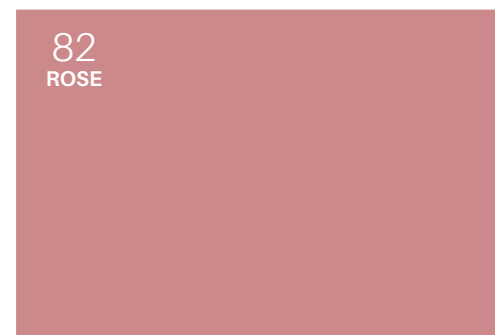

82
ROSE
Old rose matte | Rosado mate | Vieux rose mat
Altrosa matt | Rosa antico opaco
NCS S 3020 - R10B

Melamine | Melanina | Mélanine | Melamin | Melamina

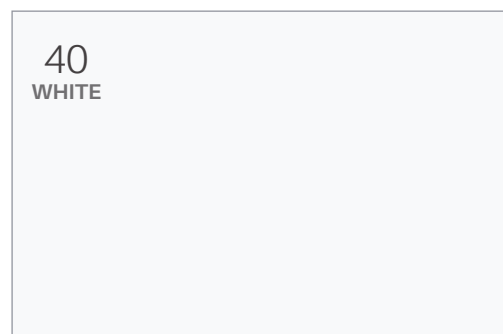

40
WHITE
White matte | Blanco mate
Blanc mat | *Weiss matt* | Bianco opaco



94
TERRA
xXXXoak | Roble blanco
Chêne clair | *Eiche weiss* | Rovere sbiancato

Wood | Madera | Bois | Holz | Legnow



91
NATURE
Natural oak | Roble natural
Chêne naturel | *Eiche natur* | Rovere naturale



92
COCO
White oak | Roble blanco
Chêne clair | *Eiche weiss* | Rovere sbiancato

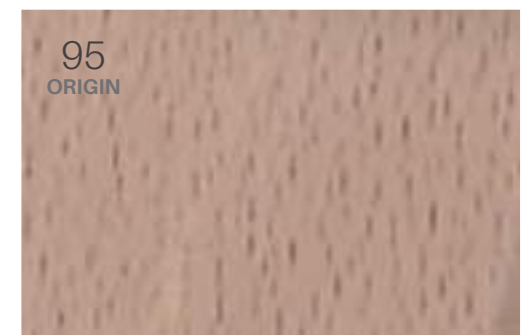

95
ORIGIN
Natural beech wood | Haya natural
Hêtre naturel | *Buche natur* | Faggio naturale

COLOURS

NURSING CHAIRS | SILLONES DE LACTANCIA FAUTEUILS D'ALLAITEMENT | *STILLSESSEL* POLTRONE ALLATTAMENTO

Leatherette | Polipiel | Similicuir | *Kunstleder* | Ecopelle



A901



P153



P178



P977

Fabric | Tela | Tissu | Stoff | Tessuto



T923



T939



052



053



055



078

NURSING BAGS | BOLSOS DE MATERNIDAD SACS Á LANGER | *WICKELTASCHEN* BORSE MAMMA

Leatherette | Polipiel | Similicuir | *Kunstleder* | Ecopelle

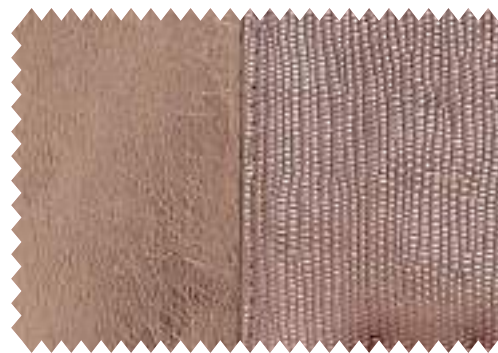

520 ROSEGOLD



521 CHAMPAGNE



522 ONIX



529 INFINITY



751 UP & DOWN BLU



752 UP & DOWN ROSA



753 ONDA ARENA



777 ONDA WHITE



ALONDRA

ALONDRA INFANTIL S.L.

Pol. Ind. Les Hortes
C/ Riu Vinalopó, 3
03778 BENIARBEIG (Alicante)
Spain

Tel. +34 966 457 290

www.alondrababy.com



[alondrababyrooms](#)



[alondrababy](#)



[alondrababyfurniture](#)



[alondrababyrooms](#)



[alondrababyroom](#)